



PASSENGER ELEVATORS

YZER-1, LUXEN-1 [60~150 m/min.]



HYUNDAI
ELEVATOR CO., LTD.

CONTENTS

04	WHY HYUNDAI ELEVATOR?	36	FIXTURES DESIGN
06	SIGNATURE PROJECTS		CLEAN MOVING SOLUTIONS
08	YZER-1		EN81-70, EN81-72
10	LUXEN-1	47	SPECIFICATIONS
12	CAR DESIGN	61	GLOBAL SALES & SERVICE NETWORK

PASSENGER ELEVATORS

YZER-1, LUXEN-1 [60~150 m/min.]

Maximize your building's value with Hyundai Elevator.

Hyundai Elevator offers elevators that can help maximize a building's value while taking into consideration future sustainability. Its Yzer-1 and Luxen-1 models use advanced technology and know-how to deliver an exceptional mobility experience that is comfortable, efficient, and eco-friendly in an elegant design.



Why Hyundai Elevator?

Factors that contribute to Hyundai Elevator's credibility and reliability.

* The world's tallest elevator test tower (300 m) at the new factory in Chungju, Korea.
 * Images of the buildings and surroundings of the test tower have been modified to help viewers' understanding. Features such as the materials, design, and CI may differ from reality.



New Chungju Factory (Korea)

Strengthening Technological Leadership With a Solid Platform Based on Trust

With smart factories in Korea and China, Hyundai Elevator aims to further improve its world-class elevator technology with manufacturing and product quality innovations that correspond to the Fourth Industrial Revolution. It plans to lead the future elevator market with creative technologies and products such as carbon fiber, belt-type elevators.

THE EL 1,260 m/min. High Speed Elevator

World-class 1,260 m/min.

The World's First 1,260 m/min. Application of Carbon Fiber Belt-type Technology

Certification



ISO 9001 ISO 14001 ISO 45001



CE YZER-1 (SSVF9) CE LUXEN-1 (STVF9)



New China Factory (China)

A Production System and Sales Network that Span Across Borders

New Chungju Headquarters (Chungju, Korea)

The new factory in Chungju consists of a smart factory that incorporates quaternary industry technologies (such as IoT, big data, and artificial intelligence), an R&D center, a logistics center, and the world's tallest elevator test tower (300 m high). It will have a production capacity of 25,000 units per year.

- Scheduled to be completed in February 2022
- 173,098 m² state-of-the-art facilities
- Production of elevators, parking systems, etc.
- The world's tallest elevator test tower (total height 300 m)
- Hyundai Customer Care Center (CCC)

New China Factory (Shanghai, China)

The Shanghai campus is equipped with a smart factory with a production capacity of 25,000 units per year, a test tower for quality checks of high-speed and observation elevators, an R&D center, and a customer care center. Hyundai Elevator will build its competitiveness in the world's largest elevator market with cutting-edge technology, steady product improvements, and cutting-edge smart factories.

- Completed smart factory in March 2021
- 105,517 m² state-of-the-art facilities
- Production of elevators and escalators
- Elevator test tower (total height 185 m; 175 m above the ground)

Overseas Subsidiaries

China	Hyundai Elevator (Shanghai) Co., Ltd.
Indonesia	Pt. Hyundai Elevator Indonesia
Malaysia	Hyundai Elevator (Malaysia) Sdn. Bhd
Brazil	Hyundai Elevadores do Brasil Ltda.
Vietnam	Hyundai Thanh Cong Elevator Vietnam Co., Limited
Turkey	Hyundai Elevator Asansör Ve Servis Sanayi Ve Ticaret Anonim Şirketi

SIGNATURE PROJECTS



A rich portfolio of projects around the world demonstrates the added value that Hyundai Elevator can offer.

1 BUSAN INTERNATIONAL FINANCE CENTER (KOREA)

Thirty-two elevators, including two 10 m/sec. (the fastest in Korea), three 9 m/sec., eight 8 m/sec., and six 6 m/sec. units as well as fourteen escalators.

2 GALLERY WEST (INDONESIA)

Twenty-three elevators, including four 4 m/sec. units as well as ten escalators.

3 F&F TOWER (PANAMA)

Five 4 m/sec. elevators.

4 METROPOL ISTANBUL (TURKEY)

Ninety-five elevators, including six 6 m/sec., one 5 m/sec., and eighteen 4 m/sec. units as well as twenty-six escalators.

5 KEANGNAM HANOI LANDMARK TOWER (VIETNAM)

Twenty-nine elevators, including two 4 m/sec. units as well as twenty-seven escalators.

6 VISTANA TROPIKA SPACE RESIDENCY (MALAYSIA)

Twenty-three elevators, including six 5 m/sec., four 4 m/sec., and three 3 m/sec. units as well as two escalators.

7 YANGON HOTEL (MYANMAR)

Twenty elevators, including five 3 m/sec., two 2.5 m/sec., and six 2 m/sec. units.

8 PARK HYATT BUSAN (KOREA)

Eleven elevators, including two 6 m/sec., three 4 m/sec., and two 3.5 m/sec. units.

9 LG U+ YONGSAN OFFICE BUILDING (KOREA)

Ten elevators, including two 4 m/sec. double deck elevators (the first in Korea), four 4 m/sec. units, two 3.5 m/sec. units, and two escalators.

10 VARYAP MERIDIAN (TURKEY)

Sixteen elevators, including seven 4 m/sec. and four 3.5 m/sec. units as well as thirty-six escalators.

MACHINE ROOM LESS ELEVATOR

YZER-1

LOWER CONSTRUCTION COSTS

SHORTER INSTALLATION PERIOD

ELEGANT DESIGN

Yzer-1 is a machine room less elevator with a minimal-sized hoistway and pit that helps to optimize space utilization in a building. It offers greater freedom in the placement of the hoistway and the design of the skyline of the building while reducing construction costs and lead times. Yzer-1 has a sophisticated design and offers convenience features that promote hygienic use.

Minimal Space and Maximum Value

Enhanced safety through the application of international standards

Ropes that meet international standards ensure safe operation.

Simple Installation, Fast Delivery

Rail mounting-type traction system

- Eliminates the need for a beam sleeve on top of the hoistway to facilitate installation

20% shorter installation period

- Eliminates the need for footholds at the top and bottom of the hoistway
- Exclusive jigs simplify the installation process

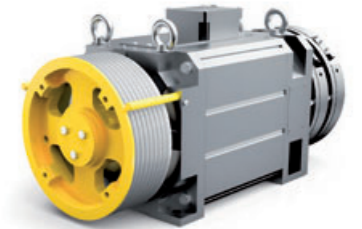

Less restrictive construction design and lower construction costs

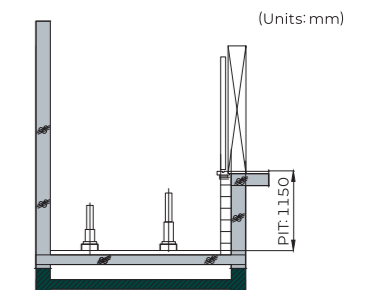
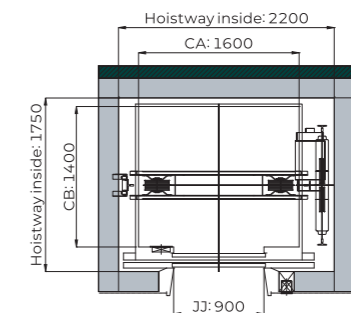

Minimum hoistway size

21% reduction of the hoistway (1,000 kg capacity elevator)

Minimum pit depth (1,150 mm)

350 mm reduction in depth ($\leq 1,150$ kg, 1.0 m/sec.)

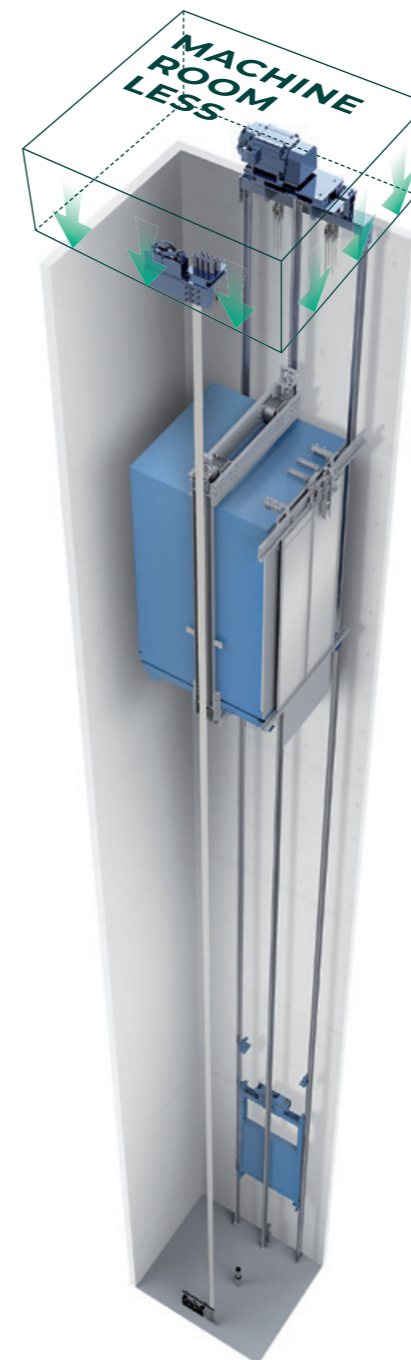

Easier maintenance and improved customer safety

High-performance, eco-friendly traction machine with a proven track record

- Oil-free traction system does not require regular oiling of the bearing unit
- Easier to maintain because on-site brake adjustment is not necessary

Eco-friendly LED ceiling

Ultra-slim LED ceiling lights are long-lasting, consume little power, and reduce eye fatigue.

* Not applicable on certain ceiling options.



Highly reliable dual brakes

Dual braking system allows brakes on one side to operate independently if brakes on the other side fail, improving safety significantly (**complies to EN81-20/50 requirements**).

MEDIUM-SPEED GEARLESS TRACTION ELEVATOR

LUXEN-1

EXCEPTIONAL RIDE QUALITY

CONVENIENT MAINTENANCE

CLASS A ENERGY EFFICIENCY

Luxen-1 is a low to medium speed gearless elevator that occupies less building space than elevators that use geared hoisting machines and offers exceptional riding comfort by eliminating vibration and trembling caused by gear meshing. A high-efficiency permanent magnet motor and power regenerative inverter deliver significant energy savings.

Exceptional ride quality and energy efficiency

High efficiency gearless synchronous traction machine

Energy savings

The gearless synchronous traction machine has a motor that uses permanent magnets and consumes 25% less energy than induction motors.

Exceptional ride quality

Noise and vibration are significantly reduced with the elimination of interlocking gears, providing extraordinary riding comfort.

Easy maintenance

The gearless traction machine does not use gear oil and is easy to maintain, eliminating the need for oil changes and reducing maintenance costs.



Regenerative inverter that recycles energy (optional)

Up to 60% energy savings (PWM Type)

Energy generated while operating the elevator is recycled for up to 60% in energy savings (77.5% energy efficiency).

Machine room heat reduction

Machine room heat is greatly reduced by recycling power generated while operating the elevator instead of dissipating heat.



The 1st Korean elevator to earn Germany's Class A energy efficiency rating



Energy Efficiency Class



Luxen-1 earned the Association of German Engineers' (VDI) highest Class A energy efficiency ratings from Germany's prestigious testing and certification agency, TÜV SÜD.

Eco-friendly LED ceiling

Ultra-slim LED ceiling lights are long-lasting, consume little power, and reduce eye fatigue.

* Not applicable on certain ceiling options.



Highly reliable dual brakes

Dual braking system allows brakes on one side to operate independently if brakes on the other side fail, improving safety significantly (**complies to EN81-20/50 requirements**).



HCE (Essence)

HCS (Simple)

HCD (Deluxe)

CAR DESIGN

Diverse car designs match your architectural concepts.

From the height of the ceiling to the lighting, the color and pattern of walls, and the flooring, cars have been carefully designed to render an elegant and comfortable space. Operating panels and indicators that are easy to use and clean moving solutions that take into consideration the hygienic use of elevators maximize users' satisfaction.

HCE-A

CAR DESIGN

Ceiling	CD-198A / Acryl, LED Downlight, Ceiling Plate (Painted Steel / P020)
Front Wall	Painted Steel (P020)
Side Walls	Painted Steel (P020)
Rear Wall	Painted Steel (P020), Stainless Mirror Etching (SE1169)
Handrails	1C / Stainless 1Pipe, Chrome Bracket
Car Doors	Painted Steel (P020)
Car Operating Panel	OPP-D521 / Stainless Hairline
Flooring	PVC (DTE2125)



Rear Image

Pattern Detail



ENTRANCE

200 TYPE

Jamb	Painted Steel (P020) / 200 Type
Doors	Painted Steel (P020)
Hall Button	HPB-621
Indicator	PI-D600

50 TYPE

Jamb	Painted Steel (P020) / 50 Type
Doors	Painted Steel (P020)
Hall Button	HIP-D621
Indicator	-



200 Type

50 Type

- Notes**
1. Product and design images have been created to help viewers' understanding. Actual colors may be different from those that are depicted.
 2. For 800 kg models and smaller, swing-type operating panels may not be applicable due to the narrow width of the front wall.



Front Image (13-passenger, 1,000 kg capacity unit)

HCE-B

CAR DESIGN

Ceiling	CD-199A/Acryl, LED Downlight, Ceiling Plate (Painted Steel / P021)
Front Wall	Painted Steel (P009)
Side Walls	Painted Steel (P009), Painted Steel (P026)
Rear Wall	Painted Steel (P009), Painted Steel (P026)
Handrails	1C / Stainless 1Pipe, Chrome Bracket
Car Doors	Painted Steel (P026)
Car Operating Panel	OPP-D582 / Stainless Hairline
Flooring	PVC (TN2601C)



Rear Image



Front Image (13-passenger, 1,000 kg capacity unit)

ENTRANCE

200 TYPE

Jamb	Painted Steel (P026) / 200 Type
Doors	Painted Steel (P026)
Hall Button	HPB-882 / Stainless Hairline
Indicator	PI-D600

50 TYPE

Jamb	Painted Steel (P026) / 50 Type
Doors	Painted Steel (P026)
Hall Button	HIP-D882 / Stainless Hairline
Indicator	-



200 Type

50 Type

- Notes**
1. Product and design images have been created to help viewers' understanding. Actual colors may be different from those that are depicted.
 2. For 700 kg models and smaller, the central wall pattern on the inner surface of side panels may be omitted due to the division line between the 2 panels.
 3. For 800 kg models and smaller, swing-type operating panels may not be applicable due to the narrow width of the front wall.



Front Image (13-passenger, 1,000 kg capacity unit)

HCE-C

ESSENCE

CAR DESIGN

Ceiling	CD-B31C / Painted Steel (P021), Acryl, Ceiling Plate (Painted Steel / P021)
Front Wall	Stainless Hairline
Side Walls	Stainless Hairline, Painted Steel (P024)
Rear Wall	Stainless Hairline, Painted Steel (P024)
Handrails	1C / Stainless 1Pipe, Chrome Bracket
Car Doors	Stainless Hairline
Car Operating Panel	OPP-D521 / Stainless Hairline
Flooring	PVC (TN2233C, DTE2246)



Rear Image

ENTRANCE

200 TYPE

Jamb	Stainless Hairline / 200 Type
Doors	Stainless Hairline
Hall Button	HPB-621
Indicator	PI-D600

50 TYPE

Jamb	Stainless Hairline / 50 Type
Doors	Stainless Hairline
Hall Button	HIP-D621
Indicator	-



200 Type

50 Type

- Notes**
1. Product and design images have been created to help viewers' understanding. Actual colors may be different from those that are depicted.
 2. For 700 kg models and smaller, the central wall pattern on the inner surface of side panels may be omitted due to the division line between the 2 panels.
 3. For 800 kg models and smaller, swing-type operating panels may not be applicable due to the narrow width of the front wall.



Front Image (13-passenger, 1,000 kg capacity unit)

HCE-D

ESSENCE

CAR DESIGN

Ceiling	CD-199A / Acryl, LED Downlight, Ceiling Plate (Painted Steel / P021)
Front Wall	Stainless Hairline
Side Walls	Stainless Hairline
Rear Wall	Stainless Hairline
Handrails	1C / Stainless 1Pipe, Chrome Bracket
Car Doors	Stainless Hairline
Car Operating Panel	OPP-D521 / Stainless Hairline
Flooring	PVC (TDSS160)



Rear Image

ENTRANCE

200 TYPE

Jamb	Stainless Hairline / 200 Type
Doors	Stainless Hairline
Hall Button	HPB-621
Indicator	PI-D600

50 TYPE

Jamb	Stainless Hairline / 50 Type
Doors	Stainless Hairline
Hall Button	HIP-D621
Indicator	-



200 Type

50 Type

Notes 1. Product and design images have been created to help viewers' understanding. Actual colors may be different from those that are depicted.
2. For 800 kg models and smaller, swing-type operating panels may not be applicable due to the narrow width of the front wall.



Front Image (13-passenger, 1,000 kg capacity unit)

HCS-A

SIMPLE

CAR DESIGN

Ceiling	CD-B31C / Acryl, Ceiling Plate (Painted Steel / P021), LED Bar Light
Front Wall	Stainless Hairline
Side Walls	Stainless Hairline
Rear Wall	Stainless Hairline, Stainless Mirror
Handrails	1C / Stainless 1Pipe, Chrome Bracket
Car Doors	Stainless Hairline
Car Operating Panel	OPP-N364 / Stainless Hairline
Indicator	PI-D90 / Smart Indicator
Flooring	PVC (TN2233C, DTE2246)



Rear Image

ENTRANCE

200 TYPE

Jamb	Stainless Hairline / 200 Type
Doors	Stainless Hairline
Hall Button	HPB-A64
Indicator	PI-D700

50 TYPE

Jamb	Stainless Hairline / 50 Type
Doors	Stainless Hairline
Hall Button	HIP-DA64
Indicator	-



200 Type

50 Type

Notes 1. Product and design images have been created to help viewers' understanding. Actual colors may be different from those that are depicted.
2. For 800 kg models and smaller, swing-type operating panels may not be applicable due to the narrow width of the front wall.

HCS-B

CAR DESIGN

Ceiling	CD-199A/Acryl, LED Downlight, Ceiling Plate (Painted Steel / P021)
Front Wall	Stainless Hairline
Side Walls	Stainless Hairline, Stainless Hairline Etching (SE1169)
Rear Wall	Stainless Hairline, Stainless Mirror
Handrails	HR-01W / Stainless 1Pipe
Car Doors	Stainless Hairline Etching (SE1169)
Car Operating Panel	OPP-D564T (EN) / Stainless Hairline
Flooring	PVC (TDS5160, DTE2126)

* EN81-70:2018 compliant

Pattern Detail



Rear Image

ENTRANCE

200 TYPE

Jamb	Stainless Hairline / 200 Type
Doors	Stainless Hairline Etching (SE1169)
Hall Button	HPB-B64 (EN)
Indicator	PI-D700
Hall Lantern	HLS-770

50 TYPE

Jamb	Stainless Hairline / 50 Type
Doors	Stainless Hairline Etching (SE1169)
Hall Button	HPB-B64 (EN)
Indicator	PI-D700
Hall Lantern	HLS-770

* EN81-70:2018 compliant



200 Type

50 Type

- Notes**
1. Product and design images have been created to help viewers' understanding. Actual colors may be different from those that are depicted.
 2. For 700 kg models and smaller, the central wall pattern on the inner surface of side panels may be omitted due to the division line between the 2 panels.
 3. For 800 kg models and smaller, swing-type operating panels may not be applicable due to the narrow width of the front wall.



Front Image (13-passenger, 1,000 kg capacity unit)



Front Image (1.3-passenger, 1,000 kg capacity unit)

HCS-C

SIMPLE

CAR DESIGN

Ceiling	CD-199B / Artmetal Silver (AM 01), LED Bar Lighting, Ceiling Plate (Painted Steel / P021)
Front Wall	Stainless Hairline
Side Walls	Stainless Hairline
Rear Wall	Stainless Hairline, Stainless Mirror
Handrails	FA / Stainless
Car Doors	Stainless Hairline Etching (SE2312)
Car Operating Panel	OPP-N521 / Stainless Hairline
Indicator	PI-L210 / Smart Indicator
Flooring	PVC (DTE5311, TN2233C)

Pattern Detail

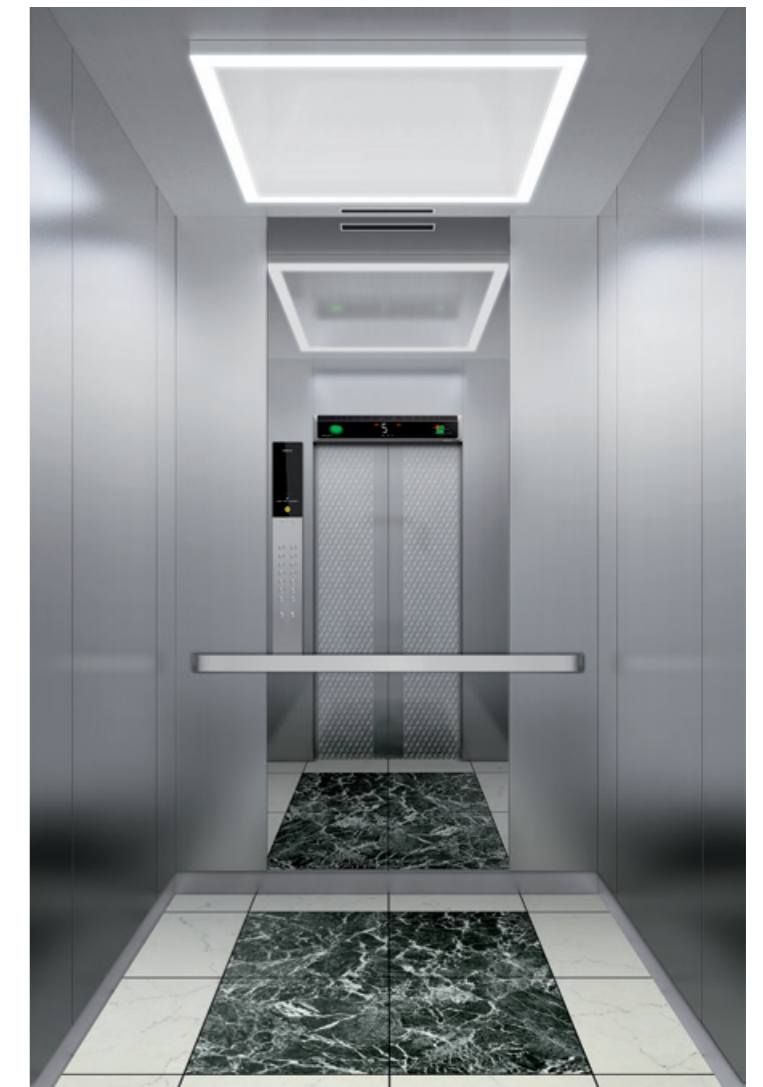
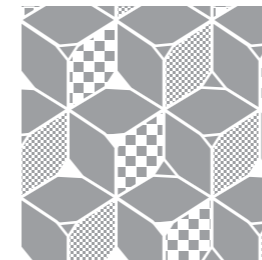

Rear Image

ENTRANCE

200 TYPE

Jamb	Stainless Hairline / 200 Type
Doors	Stainless Hairline Etching (SE2312)
Hall Button	HPB-821
Indicator	PI-D700

50 TYPE

Jamb	Stainless Hairline / 50 Type
Doors	Stainless Hairline Etching (SE2312)
Hall Button	HIP-D821
Indicator	-



200 Type

50 Type

Notes 1. Product and design images have been created to help viewers' understanding. Actual colors may be different from those that are depicted.
2. For 800 kg models and smaller, swing-type operating panels may not be applicable due to the narrow width of the front wall.



Front Image (13-passenger, 1,000 kg capacity unit)

HCD-A

DELUXE

CAR DESIGN

Ceiling	CD-191A/Titanium Gold Beadblast, LED Bar Light, Ceiling Plate (Painted Steel / P024)
Front Wall	Titanium Gold Beadblast
Side Walls	Titanium Gold Beadblast, Titanium Gold Mirror
Rear Wall	Laminated Steel (Wood / SW01)
Handrails	1C / Titanium Gold 1Pipe (Polished)
Car Doors	Titanium Gold Beadblast
Car Operating Panel	Swing type OPP-L264SW / Titanium Gold Beadblast
Flooring	PVC (TDS5160)

Pattern Detail



Rear Image

ENTRANCE

200 TYPE

Jamb	Titanium Gold Beadblast / 200 Type
Doors	Titanium Gold Beadblast
Hall Button	HPB-B64
Indicator	PI-D800

50 TYPE

Jamb	Titanium Gold Beadblast / 50 Type
Doors	Titanium Gold Beadblast
Hall Button	HIP-DB64
Indicator	-

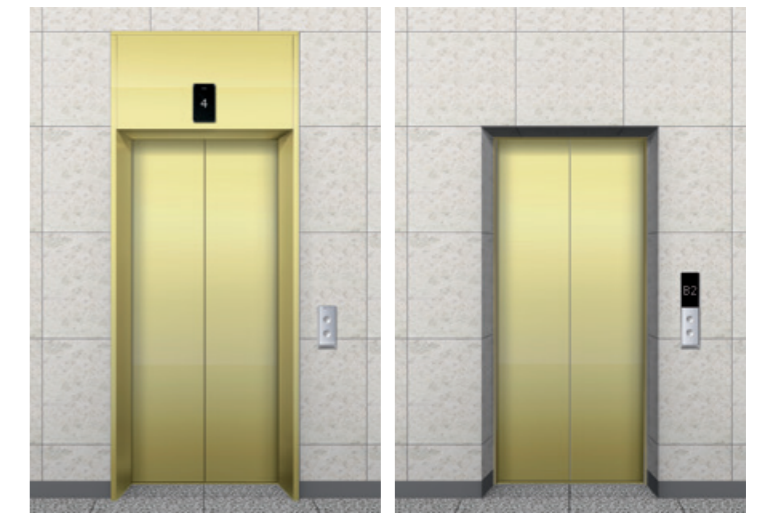

200 Type

50 Type

- Notes**
1. Product and design images have been created to help viewers' understanding. Actual colors may be different from those that are depicted.
 2. For 700 kg models and smaller, the central wall pattern on the inner surface of side panels may be omitted due to the division line between the 2 panels.
 3. For 800 kg models and smaller, swing-type operating panels may not be applicable due to the narrow width of the front wall.



Front Image (13-passenger, 1,000 kg capacity unit)

HCD-B

DELUXE

CAR DESIGN

Ceiling	CD-219A/Skylite, Ceiling Plate (Painted Steel / P022)
Front Wall	Stainless Hairline
Side Walls	Laminated Steel (Wood / SW02)
Rear Wall	Stainless Mirror, Stainless Hairline Etching (SE2310)
Handrails	1C/Stainless 1Pipe, Chrome Bracket
Car Doors	Stainless Hairline Etching (SE2310)
Car Operating Panel	Swing Type OPP-N264SW/ Stainless Hairline
Indicator	PI-L210/Smart Indicator
Flooring	PVC (TN2601C)

Pattern Detail



Rear Image

ENTRANCE

200 TYPE

Jamb	Stainless Hairline / 200 Type
Doors	Stainless Hairline Etching (SE2310)
Hall Button	HPB-B64
Indicator	PI-D800

50 TYPE

Jamb	Stainless Hairline / 50 Type
Doors	Stainless Hairline Etching (SE2310)
Hall Button	HIP-DB64
Indicator	-



200 Type

50 Type

Notes 1. Product and design images have been created to help viewers' understanding. Actual colors may be different from those that are depicted.
2. For 800 kg models and smaller, swing-type operating panels may not be applicable due to the narrow width of the front wall.



Front Image (13-passenger, 1,000 kg capacity unit)

HCD-C

DELUXE

CAR DESIGN

Ceiling	CD-451B / Acryl, Painted Steel (P032), Ceiling Plate (Painted Steel / P022)
Front Wall	Stainless Mirror
Side Walls	Stainless Mirror, Laminated Steel (Wood / SW02)
Rear Wall	Stainless Mirror Etching (SE526), Laminated Steel (Wood / SW02)
Handrails	1FW / Anti-Virus Handrail, Chrome Bracket (Korea)
Car Doors	Stainless Mirror
Car Operating Panel	OPP-L5B1 / Stainless Hairline
Flooring	PVC (TDS5160)

Pattern Detail

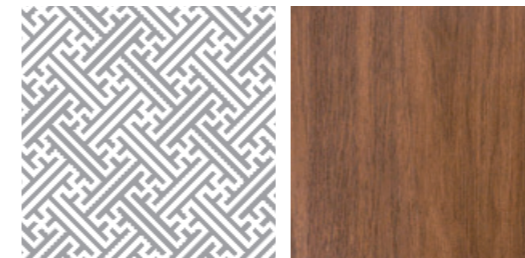

Rear Image

ENTRANCE

200 TYPE

Jamb	Stainless Hairline / 200 Type
Doors	Stainless Hairline Etching (SE526)
Hall Button	HPB-DS1D (Korea)
Indicator	PI-DC (Korea)

50 TYPE

Jamb	Stainless Hairline / 50 Type
Doors	Stainless Hairline Etching (SE526)
Hall Button	HIP-DDS1D (Korea)
Indicator	-



200 Type

50 Type

- Notes**
1. Product and design images have been created to help viewers' understanding. Actual colors may be different from those that are depicted.
 2. For 700 kg models and smaller, the central wall pattern on the inner surface of side panels may be omitted due to the division line between the 2 panels.
 3. For 800 kg models and smaller, swing-type operating panels may not be applicable due to the narrow width of the front wall.



HCD-D

DELUXE

CAR DESIGN

Ceiling	CD-B32C / Barrisol, Painted Steel (P020), Ceiling Plate (Painted Steel / P020)
Front Wall	Titanium Bronze Beadblast
Side Walls	Titanium Bronze Beadblast, Titanium Bronze Mirror
Rear Wall	Titanium Bronze Beadblast
Handrails	1C / Titanium Bronze 1 Pipe (Polished)
Car Doors	Titanium Bronze Beadblast
Car Operating Panel	Swing Type OPP-N294SW/ Titanium Bronze Beadblast (94Btn. Korea)
Indicator	PI-L210 / Smart Indicator
Flooring	PVC (DTE2109, TDS5160)



Rear Image

ENTRANCE

200 TYPE

Jamb	Titanium Bronze Beadblast / 200 Type
Doors	Titanium Bronze Beadblast
Hall Button	HPB-294 / Titanium Bronze Beadblast (94Btn. Korea)
Indicator	PI-D700

50 TYPE

Jamb	Titanium Bronze Beadblast / 50 Type
Doors	Titanium Bronze Beadblast
Hall Button	HIP-D294 / Titanium Bronze Beadblast (94Btn. Korea)
Indicator	-



200 Type

50 Type

- Notes**
1. Product and design images have been created to help viewers' understanding. Actual colors may be different from those that are depicted.
 2. For 700 kg models and smaller, the central wall pattern on the inner surface of side panels may be omitted due to the division line between the 2 panels.
 3. For 800 kg models and smaller, swing-type operating panels may not be applicable due to the narrow width of the front wall.

FIXTURES DESIGN

CAR OPERATING PANELS

D: DOT TYPE / L: LCD TYPE

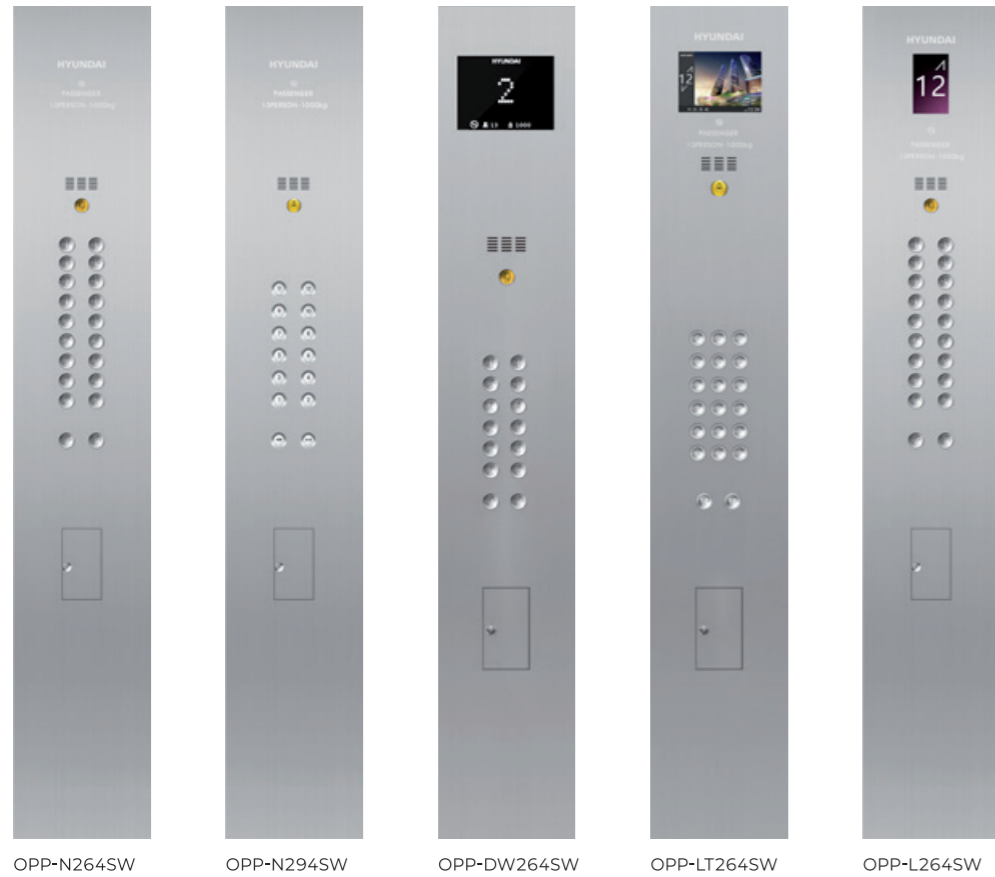

OPP-N264SW OPP-N294SW OPP-DW264SW OPP-LT264SW OPP-L264SW

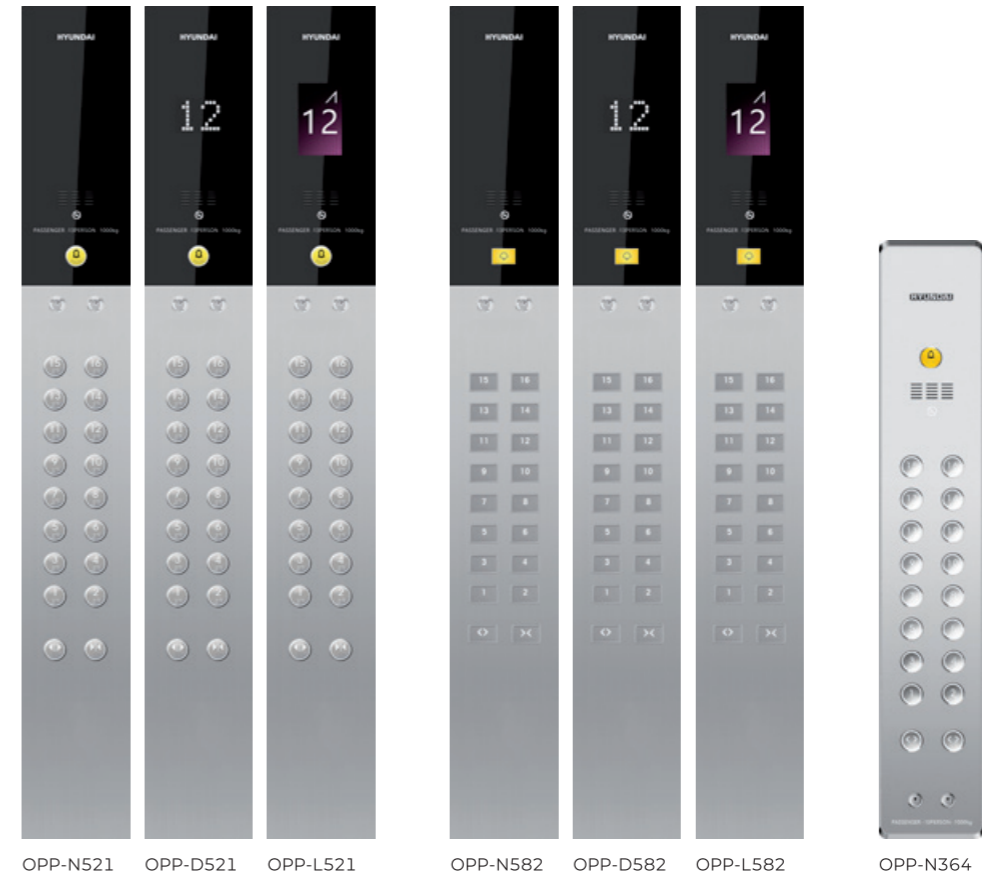

OPP-N521 OPP-D521 OPP-L521 OPP-N582 OPP-D582 OPP-L582 OPP-N364

BUTTONS

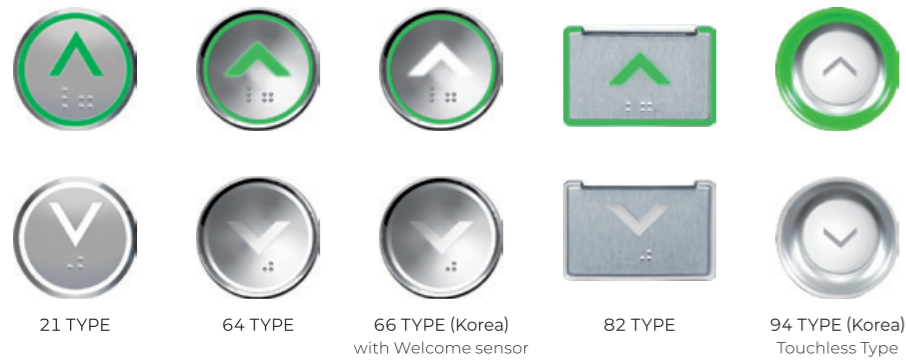

21 TYPE 64 TYPE 66 TYPE (Korea) with Welcome sensor 82 TYPE 94 TYPE (Korea) Touchless Type

HANDRAILS



1C 1FW (Korea) *EN81-70:2018 FA HR-01W *EN81-70:2018

Notes Product images have been modified to help viewers' understanding. Design and colors depicted may differ from the actual products'.

FIXTURES DESIGN

HALL BUTTONS

D: DOT TYPE / L: LCD TYPE

BOX TYPE



HIP-LT282C HIP-LT282CW



HPB-221 / HIP-D221C HIP-D221CW



HPB-294 / HIP-D294

BOXLESS TYPE



HIP-LC64 HIP-LC64W HIP-DA64W



HPB-621 / HIP-D621 HPB-A64 / HIP-DA64 HPB-B64 / HIP-DB64



HPB-821 / HIP-D821 HIP-DE21C

INDICATORS

D: DOT TYPE / L: LCD TYPE

BOX TYPE

* PI-L210 and PID90 are for the inside of the car only.



PI-L210
Applicable to center open only (jj=700, 800, 900, 1000, 1100, 1200)



PI-D90 (Korea)



PI-D600
* EN81-70:2018



PI-D800
* EN81-70:2018

BOXLESS TYPE



PI-D700
* EN81-70:2018



PI-DC (Korea)
* EN81-70:2018

HALL LANTERNS

BOX TYPE



HLS-640 HLS-770
* EN81-70:2018

BOXLESS TYPE



HLS-790

Notes Product images have been modified to help viewers' understanding. Design and colors depicted may differ from the actual products.

FIXTURES DESIGN

CLEAN MOVING SOLUTIONS

Motion Call Buttons

Touchless call buttons that respond to hand gestures

Buttons used by the public can easily transmit bacteria and viruses. Call buttons that recognize simple hand gestures through motion recognition sensors help to prevent contamination through physical contact.



Motion sensor type

Motion recognition sensors can be operated without direct contact using upward or downward hand gestures.

* Virtual images have been used to help viewers' understanding.



Surface-touch type

Hall buttons can be activated using the elbows when the hands are not free.

* Virtual images have been used to help viewers' understanding.



HPB-DS1D
(Built-in sensor type)



HIP-DDS1D
(Built-in sensor type)



Touchless Buttons

Touchless buttons for safe, contactless operation

Touchless call buttons can detect motion within 10~12 mm to summon elevators or enter destination floors. They are ideal for elevators used by large crowds, such as in hospitals and shopping malls, to prevent viral contamination and transmission through contact.



Operation principle

Electrostatic sensors detect the presence of a finger even without contact, activating the button and registering a floor number or call.

* Virtual images have been used to help viewers' understanding.

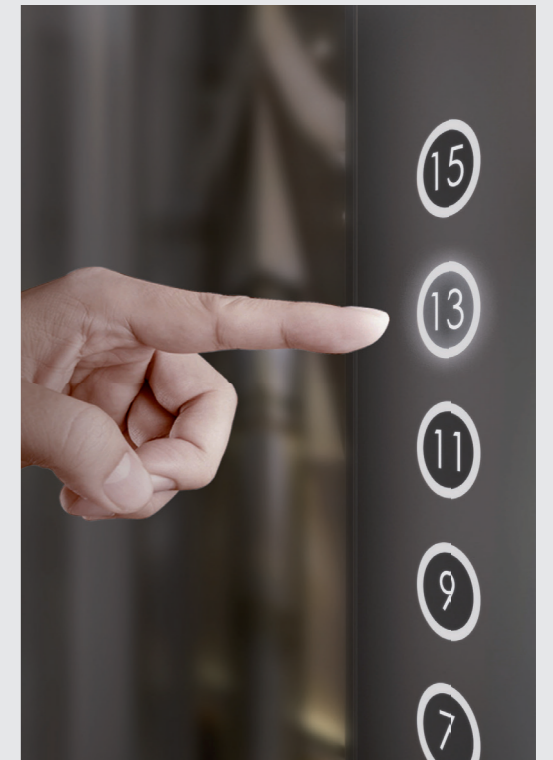

Touchless Foot Button

Call the elevator without using your hands with a touchless foot button

Use your feet to call the elevator using a sensor mounted on the bottom of the hall button. It comes in handy when you are unable to use your hands or when you are carrying luggage.



Operation principle

The world's first patented foot button comprises of a sensor mounted on the bottom of the hall button that can recognize the motion of feet. The sensor's detection area on the floor is easily recognizable and the sensor beeps when a call is registered.

* Virtual images have been used to help viewers' understanding.



Notes Product images have been modified to help viewers' understanding. Design and colors depicted may differ from the actual products'.

FIXTURES DESIGN

CLEAN MOVING SOLUTIONS

D: DOT TYPE / L: LCD TYPE

Car Operating Panels

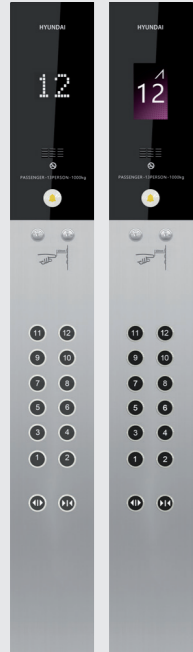

OPP-D5B1 / OPP-L5B1



OPP-L2B1SW / OPP-D2B1ASW / OPP-LT2B1SW

Hall Buttons

Motion Call Button Type



HPB-DS1D / HIP-DDS1D

HPB-621A / HIP-D621A

Touchless Button Type



HTB-AB1 / HIT-DAB1 / HIT-SAB1

Touchless Foot Button Type



HPB-B64F / HIP-DB64F / HIP-LB64AF

Buttons

Touchless Button Type



B1

EN81-70

As an elevator for the handicapped, EN81-70 offers diverse operation panels and buttons specially designed to help people with disabilities to use the elevator safely and conveniently.



EN81-72

EN81-72 meets the requirements of elevators for fire-fighting, incorporating fire-fighting equipment, control devices, and signals.



Car Operating Panels

D: DOT TYPE / L: LCD TYPE

EN81-70



OPP-D264T / OPP-L264T

OPP-D564T / OPP-L564T

EN81-72



OPP-BCK481

Buttons

EN81-70



EN64 TYPE



EN81-72



64 TYPE



Hall Buttons

D: DOT TYPE

EN81-70



HPB-B64 / HIP-DB64

HPB-664 / HIP-D664

EN81-72



HIP-BXK481

Notes Product images have been modified to help viewers' understanding. Design and colors depicted may differ from the actual products'.

FIXTURES DESIGN

CEILING

* This is based on the standard safety window size of 500 mm × 400 mm.



CD-B31C
1100 ≤ CA, 1100 ≤ CB
(Safety window is not available)



CD-B32C
1100 ≤ CA, 1100 ≤ CB
(Safety window is not available)



CD-113B
1100 ≤ CA ≤ 2100, 1100 ≤ CB ≤ 2100
(Safety window is not available)



CD-191A
1000 ≤ CA, 850 ≤ CB
(With safety window: 1100 ≤ CA, 1250 ≤ CB)



CD-198A
1100 ≤ CA, 1000 ≤ CB
(safety window is not available)

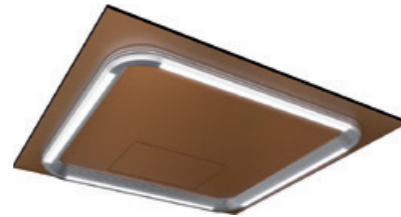

CD-199A
1100 ≤ CA, 850 ≤ CB
(With safety window: 1100 ≤ CA, 1100 ≤ CB)



CD-199B
1000 ≤ CA, 850 ≤ CB
(With safety window: 1100 ≤ CA, 1250 ≤ CB)



CD-219A
1200 ≤ CA, 850 ≤ CB
(With safety window: 1200 ≤ CA, 850 ≤ CB)



CD-253A
1200 ≤ CA, 850 ≤ CB
(With safety window: 1400 ≤ CA, 1200 ≤ CB)



CD-451B
1100 ≤ CA, 1100 ≤ CB
(With safety window: 1100 ≤ CA, 1100 ≤ CB)

ETCHING PATTERNS

* Etching patterns in this catalog are 1/3 of the actual size.

■: Relief / □: Engraving of etched parts

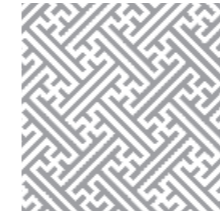

SE526



SE1168



SE1169

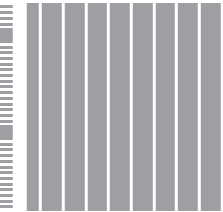

SE1591

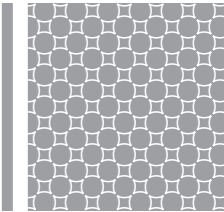

SE1673

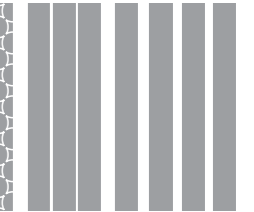

SE2302

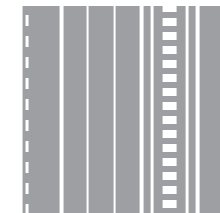

SE2310

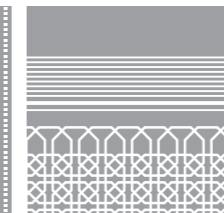

SE2311

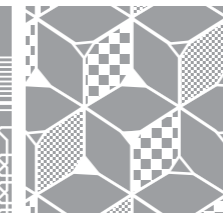

SE2312

PAINTED STEELS

* P020 and P021 are metallic colors and may appear different from the actual colors.



P003



P009



P016



P017



P019

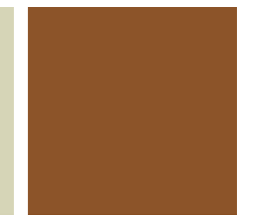

P020 (Metallic)



P021 (Metallic)

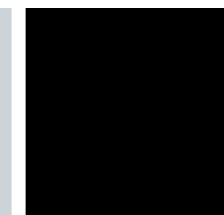

P022



P024

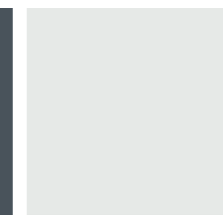

P026



P032



P033

Notes Product images have been modified to help viewers' understanding. Design and colors depicted may differ from the actual products'.

FIXTURES DESIGN

FLOORING DESIGNS

PVC

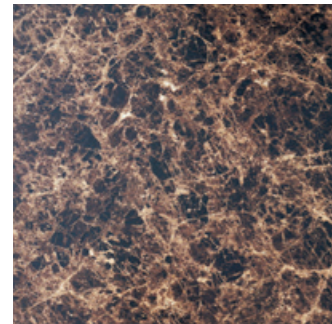

DTE2109



DTE2125



DTE2126

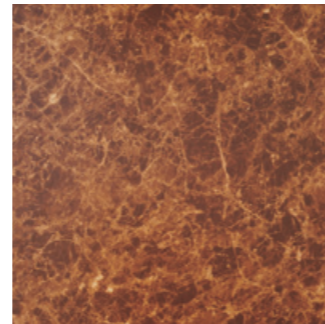

DTE2245



DTE2246



DTE2941

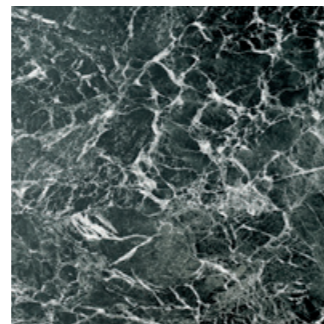

DTE5311



DTE2115

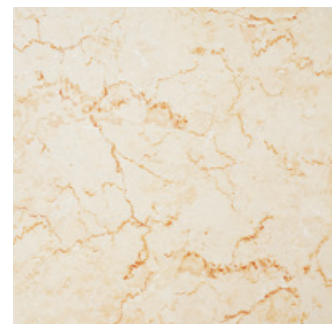

TDS5160



TN2233C



TN2601C

Notes Product images have been modified to help viewers' understanding. Design and colors depicted may differ from the actual products'.

STANDARD & OPTIONAL FEATURES

Feature	Description	Standard	Optional
Selective Collective Operation	Operation is carried out completely automatically when a call is registered.	◆	
Car Door Safety Edge with Single Side	A safety edge that runs down the full height of the door causes the door to reopen when it detects a person or obstacle while closing.	◆	
Automatic Car Light & Fan Turn-off	Car lighting and fan are turned off automatically when the car is idle to save energy.	◆	
Landing Door Interlock Device	A device integrated into the door operator prevents the car from moving when the doors are open. It locks doors completely while the car is operating to impede the opening of doors from the outside.	◆	
Interphone (Intercom)	An interphone system provides emergency communication between passengers in the car and personnel in the machine room, maintenance room, or security office.	◆	
Overload Control	A buzzer sounds and the car does not operate when passenger load exceeds maximum capacity. The buzzer stops, doors close, and the elevator starts to operate when passengers get off and weight is brought below the limit.	◆	
Low Speed self-rescue Operation	If a car stops between floors during normal operation and the safety device does not work, the car will automatically move to the nearest floor at a low speed, open its doors, and allow passengers to get off.	◆	
Parking Operation	Elevators can be automatically parked at a predetermined floor with doors closed and lights and fan turned off.		◆
Multi-beam Device for Car Doors	Multi-beams from the top to the bottom of the door detect obstructions and force the door to remain open or to reopen before it hits the obstruction.		◆
Anti-nuisance Operation	When there is a significantly larger number of calls registered than the number of passengers, the elevator prevents unnecessary operation by canceling all calls entered after it arrives at the nearest floor.		◆
Emergency Fire Operation	Cars return to a predetermined floor in the event of fire to help evacuate passengers safely.		◆
Voice Synthesizer	A voice synthesizer directs passengers with audible operational information, such as car direction, floor landed, and emergency alerts.		◆
Emergency Power Generator Operation	Power is supplied from the building's power generator and elevators operate under emergency power mode during power outages.		◆
Emergency Firefighter's Service	Firefighters can use elevators parked at a specific floor to support fire-fighting operations in the event of a fire.		◆
ELD (Emergency Landing Device)	Elevators are sent to the nearest floor using power from a rechargeable battery when power outages occur and there is no emergency power in order to prevent the trapping of passengers.		◆
Attendant Operation	The elevator's operating mode can be switched from its regular automatic mode to manual mode using the attendant's switch on the COP.		◆
Emergency Earthquake Operation	An earthquake sensor detects seismic waves and forces the elevator to stop at the nearest floor with its door fully open, preventing further operation.		◆

Notes For more information on the operation and additional service functions, please contact Hyundai Elevator.

INSTALLATION LAYOUT PLAN

YZER-1 (1.0~2.5 m/sec., 1S-CO)

PLAN OF HOISTWAY

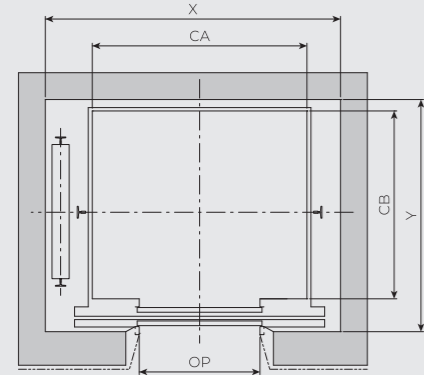

TYPICAL FLOORS

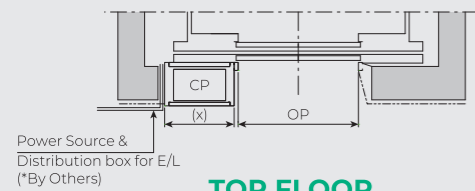

TOP FLOOR

SECTION OF HOISTWAY

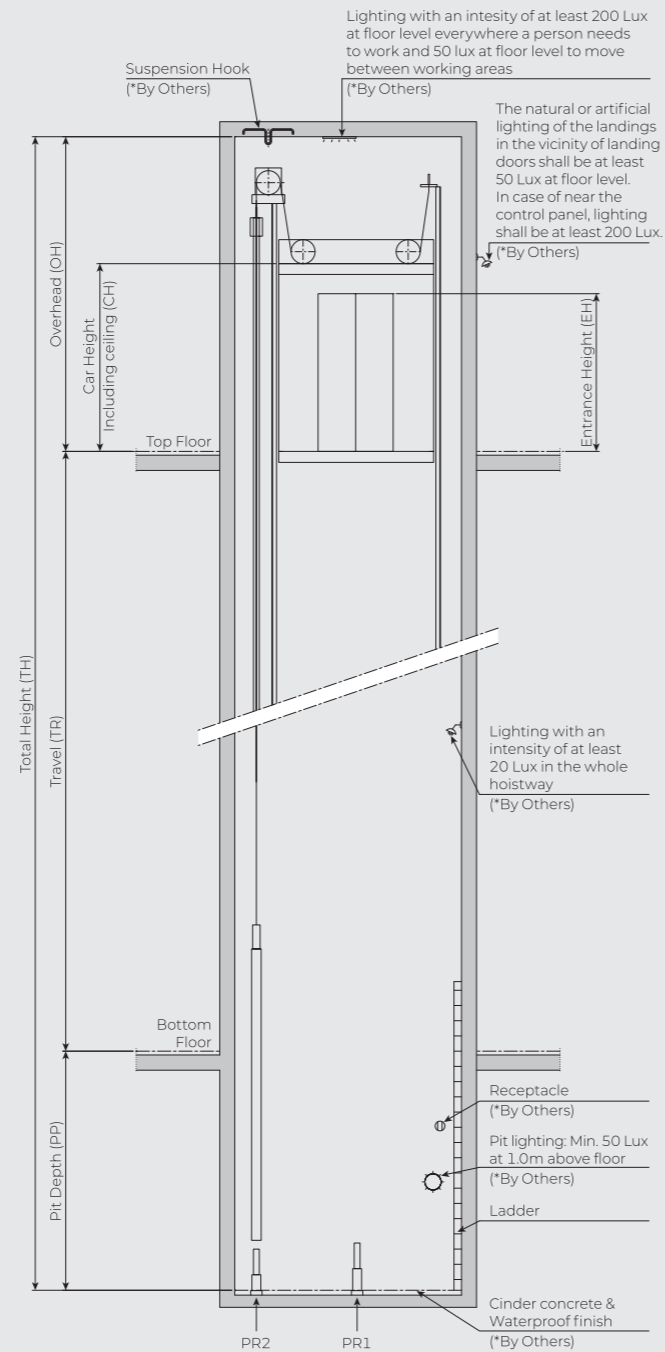

*By others: To be built by the building owner

STANDARD DIMENSIONS

YZER-1 (1.0~2.5 m/sec., 1S-CO)

STANDARD DIMENSIONS & REACTIONS

(Unit: mm)

Capacity	Speed (m/sec.)	Opening Type	Clear Opening	Car Insize (mm)	Hoistway Insize (mm)	Control Panel Box (mm)	Pit Reaction (kN)	
							CP	PR1 PR2
6	450	1.0	700	1100 × 1100	1700 × 1450		55	46
7	550	1.0	800	1100 × 1300	1800 × 1650		60	49
8	630	1.0~2.0	800	1100 × 1400	1800 × 1750	490	69	56
			800	1400 × 1100	2000 × 1450			
9	700	1.0~2.0	800	1250 × 1400	1850 × 1750	490	73	59
			800	1300 × 1400	1900 × 1750			
10	800	1.0~2.5	800	1300 × 1400	1900 × 1750	490	77	61
			900	1600 × 1300	2200 × 1650			
12	900	1.0~2.0	900	1600 × 1300	2200 × 1650	490	85	68
			900	1600 × 1400	2200 × 2050			
13	1000	2.5	900	1600 × 1400	2200 × 2050	490	94	75
			1000	1800 × 1400	2400 × 1750			
15	1150	2.5	1000	1800 × 1400	2400 × 2050	490	108	85
			1000	1800 × 1600	2550 × 1970			
18	1350	1.0~1.5	1000	1800 × 1600	2550 × 2200	490	147	118
			1000	1800 × 1600	2520 × 2200			
21	1600	1.0	1100	2000 × 1700	2750 × 2070	490	157	128
			1100	2000 × 1700	2750 × 2250			
24	1800	1.5~1.75	1100	1600 × 2300	2500 × 2650	490	94 × 2 ^{Note.7}	76 × 2 ^{Note.7}
			1100	1600 × 2300	2720 × 2250			
26	2000	1.0	1200	2100 × 1900	2825 × 2550	490	100 × 2 ^{Note.7}	80 × 2 ^{Note.7}
			1200	2100 × 1900	2825 × 2550			
33	2500	1.0~1.75	1200	2200 × 2200	2925 × 2850	490	114 × 2 ^{Note.7}	89 × 2 ^{Note.7}
			1200	2200 × 2200	2925 × 2850			

- ▲ Notes
- The above table of dimensions is as per EN81-20. In case of EN81-1 or other country codes, please contact us.
 - The persons is calculated at 75 kg per person, as required by EN81-20.
 - In case of through type (two entrances at 180 degrees), please contact us.
 - If counterweight safety gear is requested, please contact us.
 - Min. Dimension of Wall Thickness + Finished at Top floor is 250 mm for install of Control Panel.
 - The Hoistway dimensions width & depth are based on clear dimension +50 mm horizontal tolerances over the total hoistway height.
 - The car and counterweight of 1800 kg~2500 kg is Standard configuration with two buffers.

OVERHEAD & PIT DEPTH

(Unit: mm)

Capacity (kg)	Speed (m/sec.)	Max. Travel (TR(m))	Overhead(OH)		Pit Depth (PP)
			EN81-1	EN81-20	
400~550	1.0	50	CH + 1350	CH + 1500	1150
	1.0	50	CH + 1350	CH + 1500	1150
630~1150	1.5	70	CH + 1500	CH + 1600	1250
	1.75	80	CH + 1550	CH + 1700	1300
630	2.0	90	CH + 1850	CH + 1850	1500
700~1150	2.0	120	CH + 1850	CH + 1850	1500
800~1150	2.5	120	CH + 2250	CH + 2250	1700
	1.0	50	CH + 1500	CH + 1500	1300
1350~1600	1.5	70	CH + 1600	CH + 1600	1400
	1.75	80	CH + 1700	CH + 1700	1450
1350~1600	2.0	120	CH + 1850	CH + 1850	1600
	2.5	120	CH + 2150	CH + 2150	1800
1800~2500	1.0	45	CH + 1700	CH + 1700	1400
	1.5	90	CH + 1850	CH + 1850	1600
1800~2500	1.5	90	CH + 1950	CH + 1950	1650
	1.75	90	CH + 1950	CH + 1950	1650

- ◀ Notes
- CH means the Ceiling Height including the car internal ceiling height.
 - This table of dimensions is for EN81-20 & EN81-1 compliant. For other standards, please contact us.
 - To apply with the safety gear on counterweight side, Hoistway Width, OH and PIT should be increased. Please contact us.

INSTALLATION LAYOUT PLAN

YZER-1 (1.0~2.5 m/sec., 2S-SO)

PLAN OF HOISTWAY

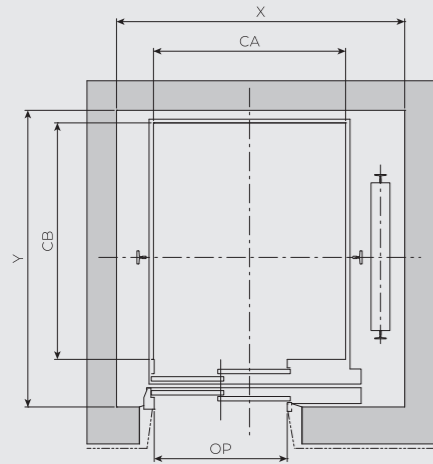

TYPICAL FLOORS

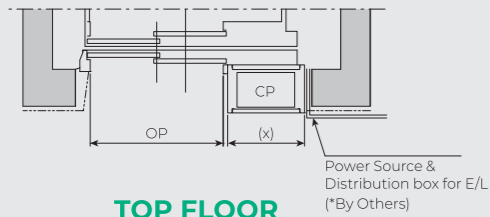

TOP FLOOR

SECTION OF HOISTWAY

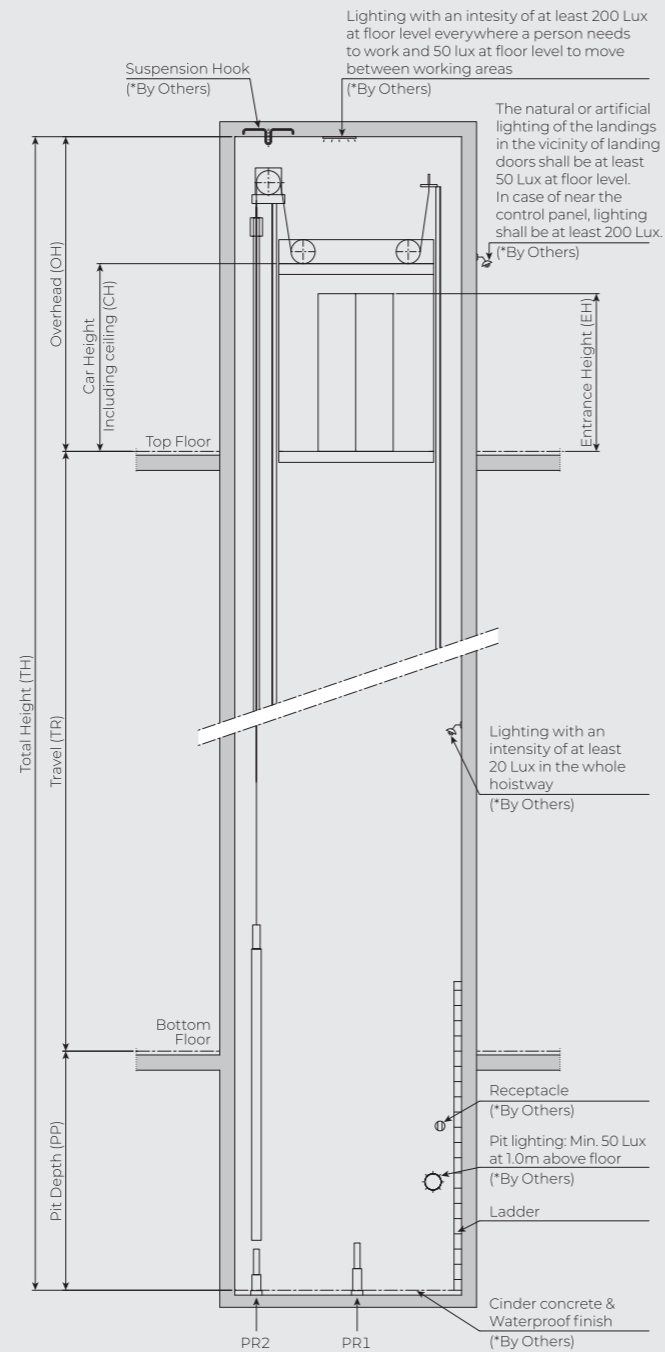

*By others: To be built by the building owner

STANDARD DIMENSIONS

YZER-1 (1.0~2.5 m/sec., 2S-SO)

STANDARD DIMENSIONS & REACTIONS

(Unit: mm)

Capacity Persons	Capacity kg	Speed (m/sec.)	Opening Type	Clear Opening		Car Insize (mm)		Hoistway Insize (mm)		Control Panel Box (mm)		Pit Reaction (kN)		
				OP	CA × CB	X × Y	CP	PR1	PR2					
5	400	1.0	2S-SO	800	1000 × 1100	1600 × 1500	490	Remote Control Box: 240W × 680H CP: In Hoistway	52	44				
6	450	1.0		800	1100 × 1100	1700 × 1550			55	46				
7	550	1.0		800	1100 × 1300	1700 × 1700			60	49				
8	630	1.0~2.0		900	1100 × 1400	1700 × 1800			69	56				
9	700	1.0~2.0		900	1200 × 1400	1800 × 1800			73	59				
10	800	1.0~2.5		900	1300 × 1400	1900 × 1800			77	61				
12	900	1.0~2.5		900	1300 × 1600	1900 × 2000			85	68				
13	1000	1.0~2.0		900	1100 × 2100	1700 × 2500			490	Remote Control Box: 240W × 680H CP: In Hoistway	94	75		
		2.5		1200	2100 × 1100	2700 × 1550					490	Remote Control Box: 240W × 680H CP: In Hoistway		
		1.0~2.0		1200	2100 × 1100	2700 × 1850					490			
15	1150	1.0~2.0		2S-SO	1000	1200 × 2200			1800 × 2650	490	Remote Control Box: 240W × 680H CP: In Hoistway	108	85	
		2.5							1800 × 2650			2050 × 2750	490	Remote Control Box: 240W × 680H CP: In Hoistway
		1.0~1.5	1100				1300 × 2300	2050 × 2750	147			118		
18	1350	1.75	2S-SO	1100	1300 × 2300	2050 × 2750	490	Remote Control Box: 240W × 680H CP: In Hoistway	147	118				
		2.0~2.5				1200					1400 × 2400	2150 × 2850	490	Remote Control Box: 240W × 680H CP: In Hoistway
		1.0				1200					1400 × 2400	2150 × 2850		
21	1600	1.5~1.75	2S-SO	1200	1400 × 2400	2150 × 2850	490	Remote Control Box: 240W × 680H CP: In Hoistway	157	128				
		2.0~2.5				1200					1500 × 2500	2300 × 2950	490	Remote Control Box: 240W × 680H CP: In Hoistway
		1.0				1200					1500 × 2500	2300 × 2950		
24	1800	1.5~1.75	2S-SO	1200	1500 × 2500	2300 × 2950	490	Remote Control Box: 240W × 680H CP: In Hoistway	94 × 2 ^{Note.7}	76 × 2 ^{Note.7}				
		1.0				1300					1600 × 2500	2400 × 2950	490	Remote Control Box: 240W × 680H CP: In Hoistway
		1.5~1.75				1300					1600 × 2500	2400 × 2950		
26	2000	1.5~1.75	2S-SO	1300	1600 × 2500	2400 × 2950	490	Remote Control Box: 240W × 680H CP: In Hoistway	100 × 2 ^{Note.7}	80 × 2 ^{Note.7}				
		1.0				1400					1800 × 2700	2600 × 3150	490	Remote Control Box: 240W × 680H CP: In Hoistway
		1.5~1.75				1400					1800 × 2700	2600 × 3150		

- ▲ Notes
- The above table of dimensions is as per EN81-20. In case of EN81-1 or other country codes, please contact us.
 - The persons is calculated at 75 kg per person, as required by EN81-20.
 - In case of through type (two entrances at 180 degrees), please contact us.
 - If counterweight safety gear is requested, please contact us.
 - Min. Dimension of Wall Thickness + Finished at Top floor is 250 mm for install of Control Panel.
 - The Hoistway dimensions width & depth are based on clear dimension +50 mm horizontal tolerances over the total hoistway height.
 - The car and counterweight of 1800 kg~2500 kg is Standard configuration with two buffers.

OVERHEAD & PIT DEPTH

(Unit: mm)

Capacity (kg)	Speed (m/sec.)	Max. Travel (TR(m))	Overhead(OH)		Pit Depth (PP)
			EN81-1	EN81-20	
400~550	1.0	50	CH + 1350	CH + 1500	1150
	1.0	50	CH + 1350	CH + 1500	1150
630~1150	1.5	70	CH + 1500	CH + 1600	1250
	1.75	80	CH + 1550	CH + 1700	1300
630	2.0	90	CH + 1850	CH + 1850	1500
700~1150	2.0	120	CH + 1850	CH + 1850	1500
800~1150	2.5	120	CH + 2250	CH + 2250	1700
	1.0	50	CH + 1500	CH + 1500	1300
1350~1600	1.5	70	CH + 1600	CH + 1600	1400
	1.75	80	CH + 1700	CH + 1700	1450
	2.0	120	CH + 1850	CH + 1850	1600
1800~2500	2.5	120	CH + 2150	CH + 2150	1800
	1.0	45	CH + 1700	CH + 1700	1400
1800~2500	1.5	90	CH + 1850	CH + 1850	1600
	1.75	90	CH + 1950	CH + 1950	1650

- ◀ Notes
- CH means the Ceiling Height including the car internal ceiling height.
 - This table of dimensions is for EN81-20 & EN81-1 compliant. For other standards, please contact us.
 - To apply with the safety gear on counterweight side, Hoistway Width, OH and PIT should be increased. Please contact us.

INSTALLATION LAYOUT PLAN

LUXEN-1 (1.0~2.5 m/sec.)

PLAN OF HOISTWAY

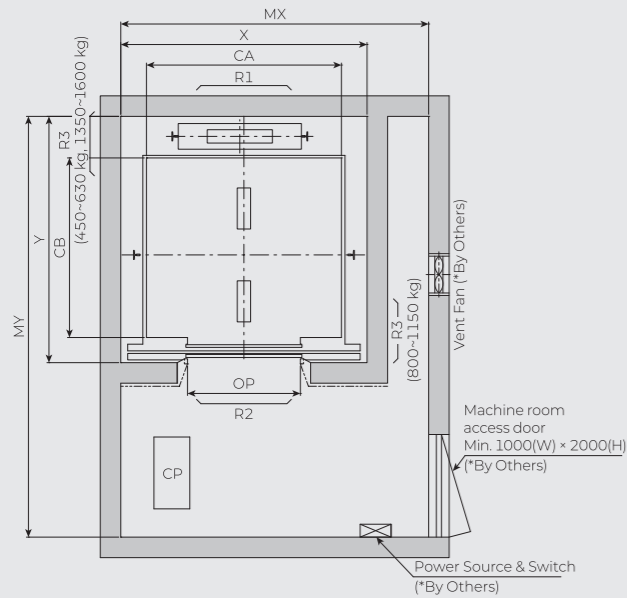

▲ Notes Angle of car sheave can be changed depending on the car size.

1S-CO

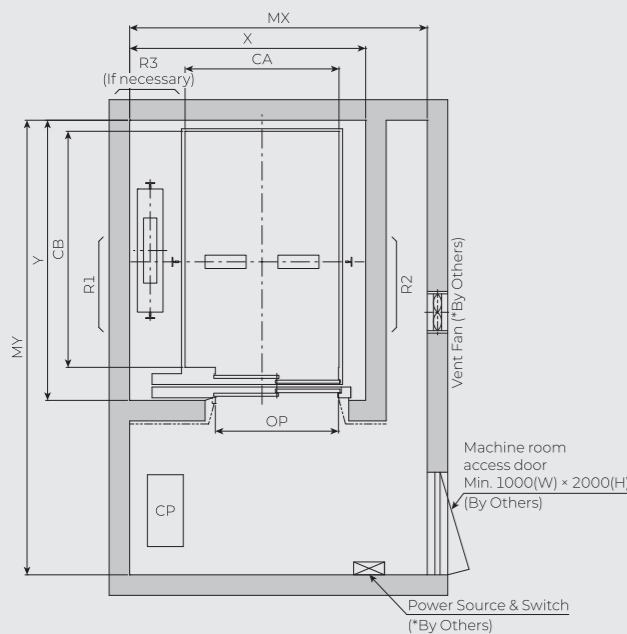

2S-SO

*By others: To be built by the building owner

SECTION OF HOISTWAY

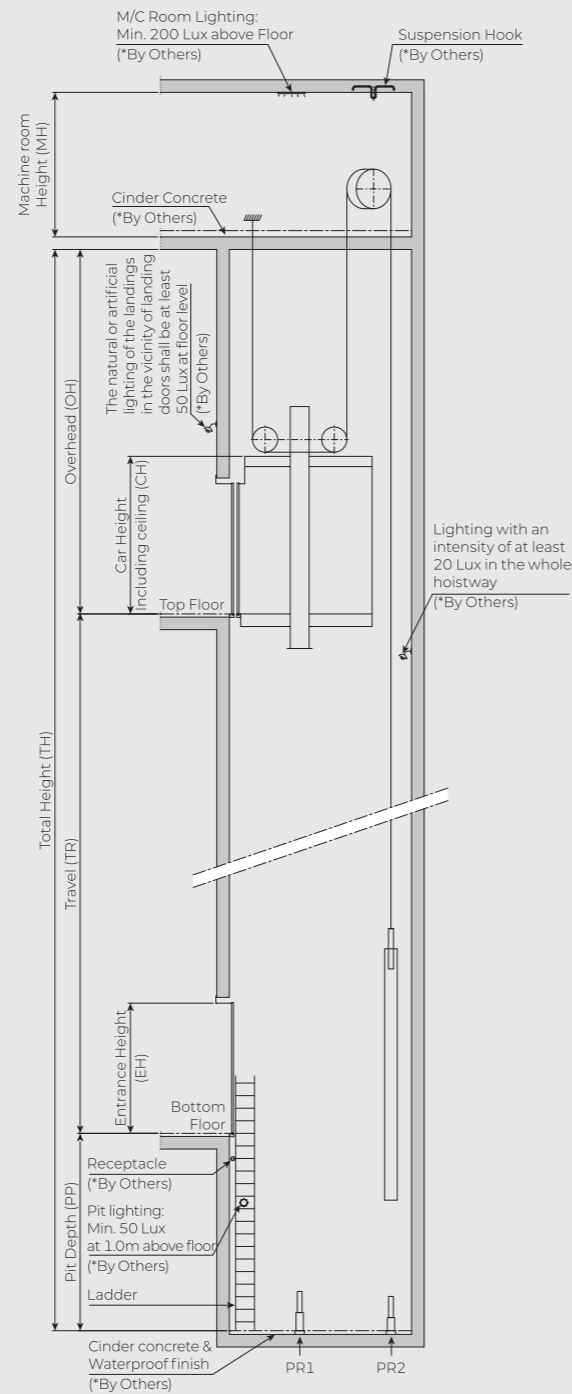

STANDARD DIMENSIONS

LUXEN-1 (1.0~2.5 m/sec.)

STANDARD DIMENSIONS & REACTIONS

(Unit: mm)

Capacity Persons	kg	Speed (m/sec.)	Opening Type	Door Width (mm) OP	CWT Drop	Car Insize (mm) CA × CB	Hoistway Insize (mm) X × Y	Machine Room Size (mm) MX × MY	M/C Room Reaction (kN)			Pit Reaction (kN)	
									R1	R2	R3	PR1	PR2
6	450	1.0~1.75		800	Rear	1400 × 850	1800 × 1450 ^{Note.6}	2400 × 3150	29	44	11	53	44
						1100 × 1350	1900 × 1700	2500 × 3400	34.7	25	-	48.8	37.8
7	550	1.0~1.75		800	Rear	1400 × 1030	1800 × 1650 ^{Note.6}	2400 × 3350	32	48	12	59	48
						1100 × 1400	1900 × 1750	2500 × 3450	48	25	-	53	41
8	630	1.0~2.0		800	Rear	1400 × 1100	1800 × 1700 ^{Note.6}	2400 × 3400	34	51	13	63	50
						1100 × 1800	1900 × 2150	2500 × 3850	57	35	-	69.8	53.5
10	800	2.5		800	Side	1350 × 1400	2150 × 1750	2750 × 3450	66.7	46.8	-	77.2	61.2
						1400 × 1350	1850 × 2000 ^{Note.6}	2450 × 3700	57	25	17.5	61	45
13	1000	1.0~1.75	1S-CO	900	Rear	1850 × 2000	2450 × 3700	2450 × 3700	57	25	17.5	61	45
						1100 × 2100	2000 × 2450	2600 × 4150	68	40	-	80	59.6
15	1150	2.5		1000	Side	1400 × 1600	2200 × 1950	2800 × 3650	73.6	51.2	-	86.3	65.9
						1600 × 1500	2050 × 2150 ^{Note.6}	2650 × 3850	68	25	20	71	51
18	1350	1.0~2.5		1000	Rear	1250 × 2100	2150 × 2450	2750 × 4150	68	25	20	71	51
						1500 × 1800	2300 × 2150	2900 × 3850	72.8	50.8	-	89.6	66.6
21	1600	1.0~2.5		1100	Side	1800 × 1500	2250 × 2150	2850 × 3850	80.8	56.8	-	96.1	72.6
						1300 × 2300	2300 × 2650	2900 × 4350	110	61.2	7	124	104
24	1800	1.0~1.75		1200	Rear	1800 × 1700	2200 × 2350	2800 × 4050	110	61.2	7	124	104
						1500 × 2300	2500 × 2650	3100 × 4350	119	62	7	140	114.4
26	2000	1.0~1.75		1200	Rear	2000 × 1750	2400 × 2400	3000 × 4100	119	62	7	140	114.4
						2100 × 1800	2650 × 2500 ^{Note.6}	3250 × 4200	103.9	83.3	-	166.6	127.4

Capacity Persons	kg	Speed (m/sec.)	Opening Type	Door Width (mm) OP	CWT Drop	Car Insize (mm) CA × CB	Hoistway Insize (mm) X × Y	Machine Room Size (mm) MX × MY	M/C Room Reaction (kN)			Pit Reaction (kN)	
									R1	R2	R3	PR1	PR2
10	800	1.0~2.0		900	Side	1100 × 1700	1800 × 2150	1800 × 3850	57	35	-	69.8	53.5
						1100 × 2100	1800 × 2550	1800 × 4250	66.7	46.8	-	77.2	61.2
13	1000	1.0~2.0	2S-SO	900	Side	1100 × 2100	1800 × 2550	1800 × 4250	68	40	-	80	59.6
						1200 × 2100	1900 × 2550	1900 × 4250	73.6	51.2	-	86.3	65.9
15	1150	1.0~2.0		1000	Side	1200 × 2100	1900 × 2550	1900 × 4250	72.8	50.8	-	89.6	66.6
						1300 × 2300	2050 × 2750	2050 × 4450	80.8	56.8	-	96.1	72.6
18	1350	1.0~2.5		1100	Side	1500 × 2300	2250 × 2750	2250 × 4450	110	61.2	7	124	104
						1500 × 2300	2250 × 2750	2250 × 4450	119	62	7	140	114.4

- ▲ Notes
- The above table of dimensions is as per EN81-20, In case of EN81-1 applied or other country codes, Please contact us.
 - The persons is calculated at 75 kg per person, as required by EN81-20
 - In case of through type (two entrances at 180 degrees), please contact us.
 - If counterweight safety gear is requested, please contact us.
 - The Hoistway dimensions width & depth are based on clear dimension +50 mm horizontal tolerances over the total hoistway height.
 - The optional hoistway size applying the special structure. Please contact us for the details.

OVERHEAD & PIT DEPTH

(Unit: mm)

Capacity (kg)	Speed (m/sec.)	Max. Travel (TR(m))	Overhead(OH)		Pit Depth (PP)	M/C Room Height (MH)
			EN81-1	EN81-20		
550~630	1.0	50	CH + 1700	CH + 1700	1250	2200
	1.5	75	CH + 1800	CH + 1800	1300	2200
	1.75	75	CH + 1900	CH + 1900	1350	2200
800~1150	1.0	50	CH + 1700	CH + 1700	1250	2200
	1.5	75	CH + 1800	CH + 1800	1300	2200
	1.75	100	CH + 1900	CH + 1900	1350	2200
	2.0	120	CH + 2100	CH + 2100	1500	2200
800	1.0	130				2200
	1000	140	CH + 2350	CH + 2350	1700	2200
1150	1.0	150				2200
	1.0	50	CH + 1800	CH + 1900	1400	2200
1350~1600	1.5	75	CH + 1900	CH + 2000	1500	2200
	1.75	90	CH + 1950	CH + 2100	1500	2200
	2.0	100	CH + 2050	CH + 2200	1550	2200
	2.5	130	CH + 2250	CH + 2400	1900	2200
1800~2000	1.0	50	CH + 1800	CH + 1850	1400	2400
	1.5	75	CH + 1900	CH + 2000	1500	2400
	1.75	90	CH + 1950	CH + 2050	1500	2400

- ▲ Notes
- CH means the Ceiling Height including the car internal ceiling height.
 - This table of dimensions is for EN81-20 & EN81-1 compliant. For other standards, please contact us.
 - If car roof trap door is applied, the OH can increase.
 - If RGS(Roller Guide Shoe) is applied as an option, the OH & Pit height can increase.
 - To apply with the safety gear on counterweight side, Hoistway Width, OH and PIT should be increased. Please contact us.

ENTRANCE LAYOUT

ENTRANCE

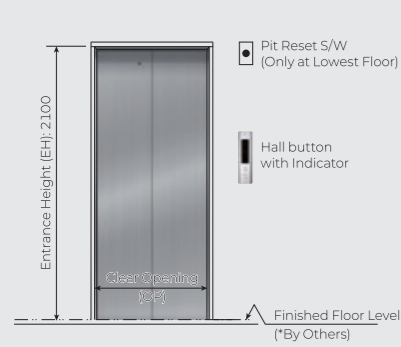

E050 TYPE (STANDARD)

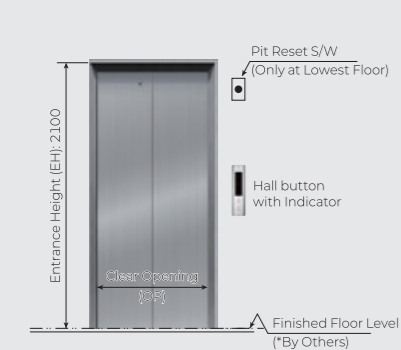

E100 TYPE (OPTIONAL)

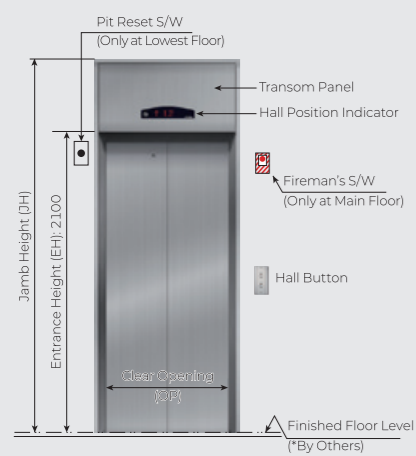

E200 TYPE (OPTIONAL)

*By others: To be built by the building owner

Notes Pit Reset S/W is only required if EN81-20 is applied.

STRUCTURAL OPENING OF ENTRANCE

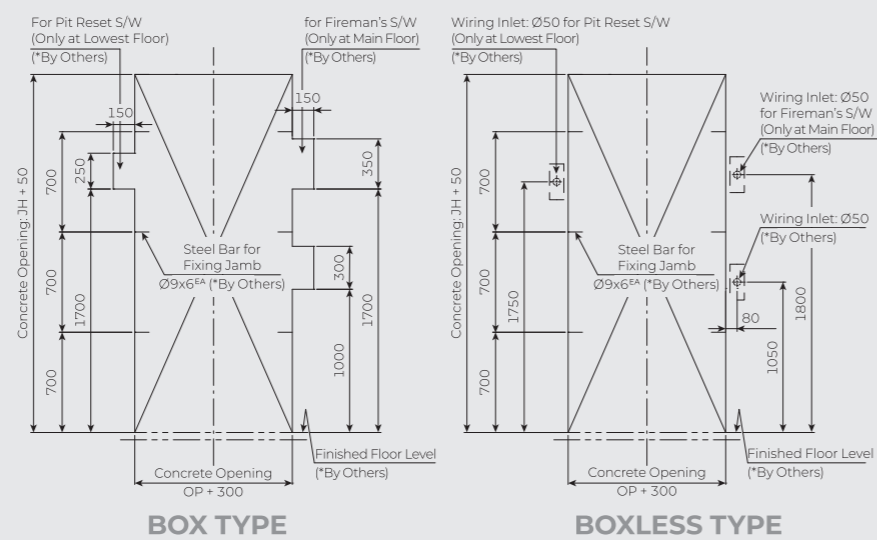
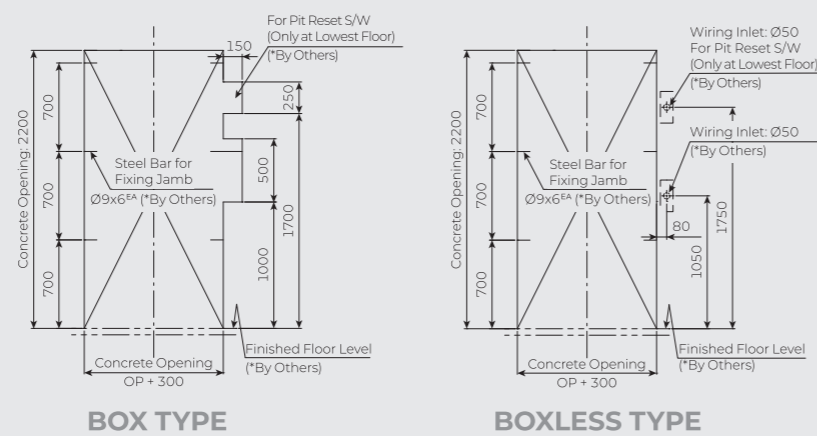
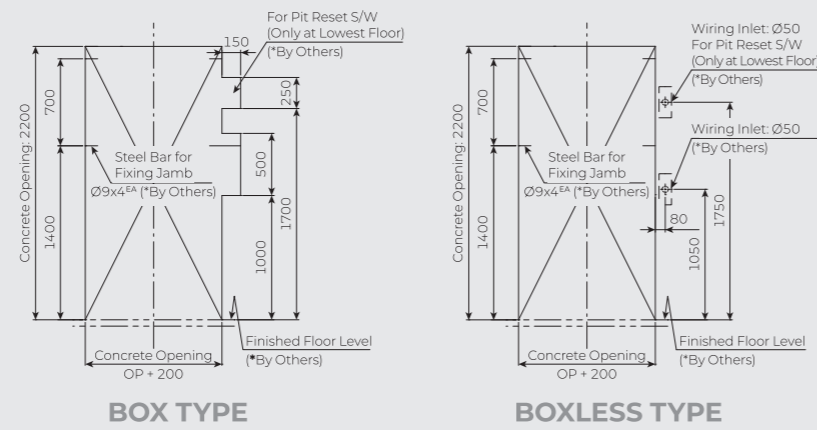

ENTRANCE LAYOUT

Only for Top Floor of the Machine room less Elevators

ENTRANCE

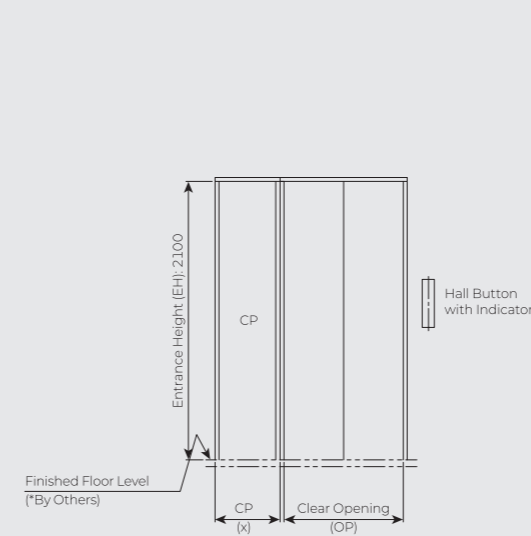

WE050 TYPE (STANDARD)

STRUCTURAL OPENING OF ENTRANCE

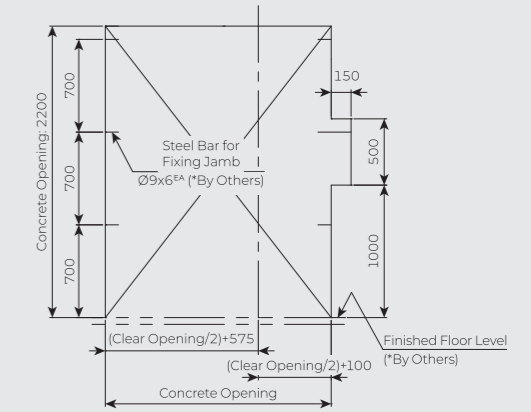

WE050 TYPE (STANDARD)

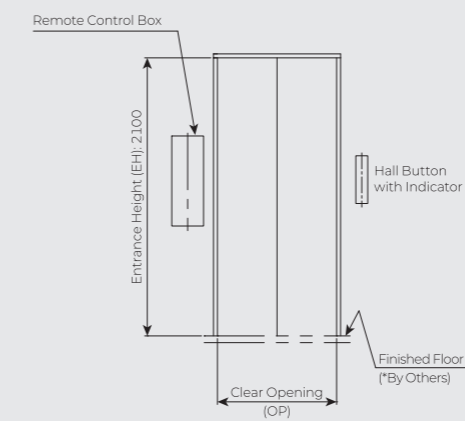

E050 TYPE WITH CP IN HOISTWAY

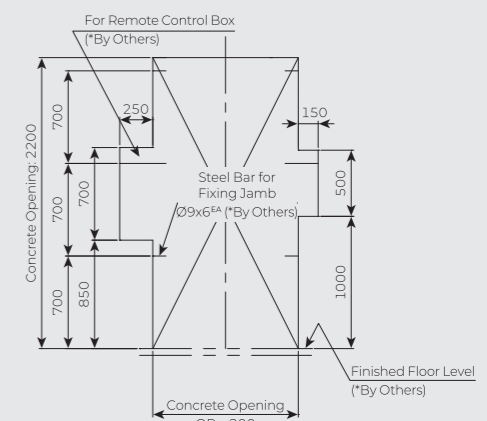

E050 TYPE WITH CP IN HOISTWAY

*By others: To be built by the building owner

Notes 1. The Control Panel size shall be followed the standard dimension table of YZER-1.
2. In case of E050 type with installed CP in hoistway, Remote control box size is based on EN81-20. If EN81-1 is applied, please consult with us.

ENTRANCE LAYOUT

2-Panel Center-Opening Doors (1S-CO)

PLAN OF ENTRANCE

Building Structure
(*By others)

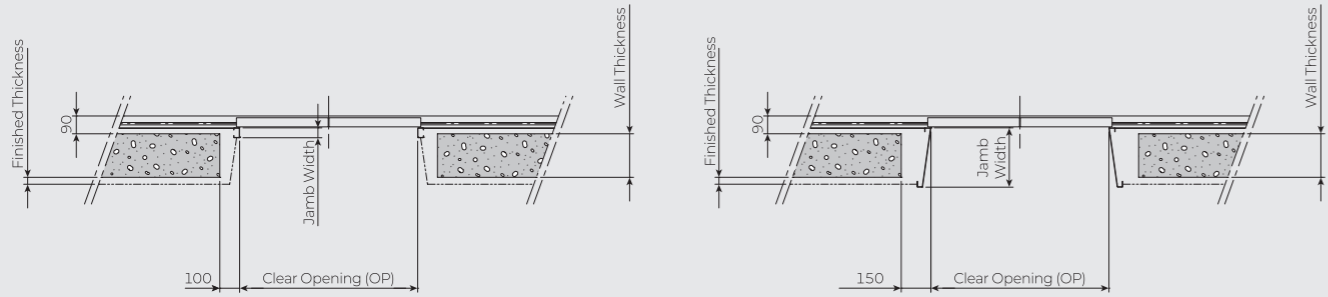

E050 TYPE

E100, 200 TYPE

ENTRANCE LAYOUT

2-Panel Side-Opening Doors (2S-SO)

PLAN OF ENTRANCE

Building Structure
(*By others)

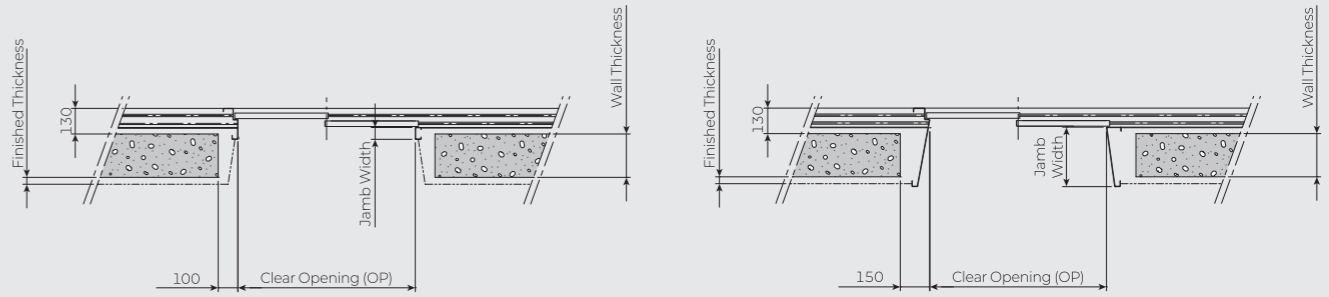

E050 TYPE

E100, 200 TYPE

SECTION OF ENTRANCE

Building Structure
(*By others)

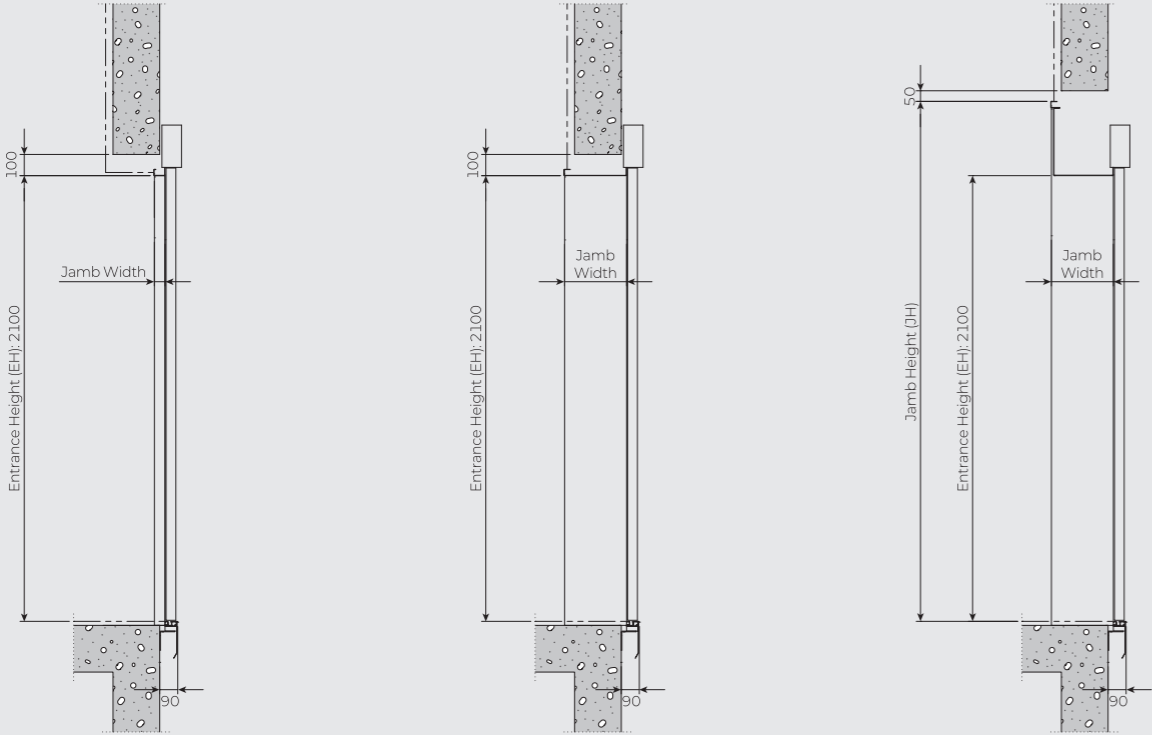

E050 TYPE

E100 TYPE

E200 TYPE

SECTION OF ENTRANCE

Building Structure
(*By others)

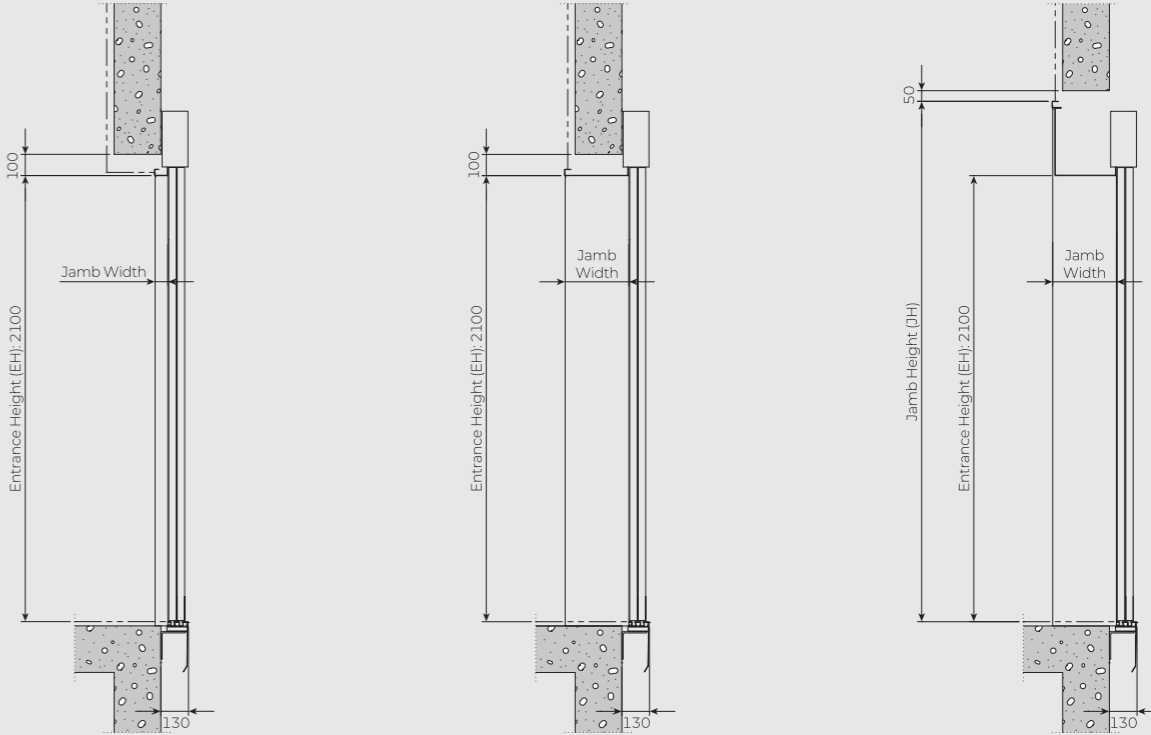

E050 TYPE

E100 TYPE

E200 TYPE

*By others: To be built by the building owner

*By others: To be built by the building owner

ELECTRIC POWER REQUIREMENTS

YZER-1 (*By Others)

POWER SUPPLY PLAN

(380V)

Capacity (kg)	Speed (m/sec.)	Motor Capacity (kW)	MCCB Capacity of Building (A)		Power Supply Capacity (kVA)		Power Cable Size (mm ²)		Earth Wire Size (mm ²)	
			1 Car	2 Cars	1 Car	2 Cars	1 Car	2 Cars	1 Car	2 Cars
400	1.0	2.7	32	75	6	10	6	16	6	16
450	1.0	3.0	32	75	7	13	6	16	6	16
550	1.0	3.7	32	75	7	13	6	16	6	16
630	1.0	4.2	32	75	8	17	6	16	6	16
	1.5	6.3	32	75	14	28	6	16	6	16
	1.75	7.4	32	75	14	28	6	16	6	16
	2.0	9.8	32	75	19	38	6	16	6	16
700	1.0	4.7	32	75	8	17	6	16	6	16
	1.5	7.0	32	75	15	29	6	16	6	16
	1.75	8.3	32	75	15	29	6	16	6	16
	2.0	10.3	32	75	20	39	6	16	6	16
800	1.0	5.3	32	75	9	19	6	16	6	16
	1.5	8.0	32	75	17	33	6	16	6	16
	1.75	9.4	32	75	17	33	6	16	6	16
	2.0	10.7	32	75	21	41	6	16	6	16
900	2.5	14.7	50	100	28	57	10	25	10	16
	1.0	6.1	32	75	11	22	6	16	6	16
	1.5	9.0	40	80	19	38	10	25	10	16
	1.75	10.6	40	80	19	38	10	25	10	16
1000	2.0	12.7	40	80	23	45	10	25	10	16
	2.5	14.9	50	100	29	57	10	25	10	16
	1.0	6.7	32	75	12	25	6	16	6	16
	1.5	10.0	40	80	21	42	10	25	10	16
1150	1.75	11.7	40	80	21	42	10	25	10	16
	2.0	13.9	40	80	25	49	10	25	10	16
	2.5	17.9	63	150	35	69	16	35	16	25
	1.0	7.7	32	75	14	28	6	16	6	16
1350	1.5	11.5	40	80	22	44	10	25	10	16
	1.75	12.3	40	80	22	44	10	25	10	16
	2.0	14.1	40	80	25	50	10	25	10	16
	2.5	18.8	63	150	36	72	16	35	16	25
1600	1.0	9.2	32	75	19	38	6	16	6	16
	1.5	13.8	50	100	28	55	10	25	10	16
	1.75	16.1	63	150	31	61	16	35	16	25
	2.0	17.6	63	150	34	67	16	35	16	25
1800	2.5	22.1	80	150	42	85	25	50	16	35
	1.0	10.8	40	80	23	45	10	25	10	16
	1.5	16.3	63	150	32	65	16	35	16	25
	1.75	19.0	63	150	36	72	16	35	16	25
2000	2.0	20.8	63	150	40	79	16	35	16	25
	2.5	26	80	150	50	99	25	50	16	35
	1.0	12.1	40	80	23	45	10	25	10	16
	1.5	18.1	63	150	38	76	16	35	16	25
2500	1.75	21.1	63	150	38	76	16	35	16	25
	1.0	13.4	40	80	25	50	10	25	10	16
	1.5	20.1	80	150	42	85	25	50	16	35
	1.75	23.4	80	150	42	85	25	50	16	35
2500	1.0	16.7	63	150	30	60	16	35	16	25
	1.5	25.1	80	150	50	99	25	50	16	35
2500	1.75	29.3	80	150	50	99	25	50	16	35

- ▲ Notes 1. The above table is for lengths of electric wire to 50 meters from the machine room to the building transformer.
2. If the cable lengths above 50meters, the following formula should be applied:

$$\text{Power feeder size (mm}^2\text{)} = \frac{\text{Power feeder length(m)}}{50} \times \text{Size in the above (mm}^2\text{)}$$

3. The above power feeder thickness are based on copper wires use and metallic tubing.
4. It is recommended a larger diameter earth wire be used.
5. Please consult us if you need electric power requirements for 220V or 440V Class.
6. For installing several elevators, apply the following formula
Transformer Capacity[kVA] = Number of elevator × Diversity factor

Number of Elevator	1	2	3	4	5
Deversity Factor	1.00	0.91	0.85	0.8	0.76

*By others: To be built by the building owner

ELECTRIC POWER REQUIREMENTS

LUXEN-1 (*By Others)

POWER SUPPLY PLAN

(380V)

Capacity (kg)	Speed (m/sec.)	Motor Capacity (kW)	MCCB Capacity of Building (A)		Power Supply Capacity (kVA)		Power Cable Size (mm ²)		Earth Wire Size (mm ²)	
			1 Car	2 Cars	1 Car	2 Cars	1 Car	2 Cars	1 Car	2 Cars
550	1.0	5.0	32	75	10	20	6	16	6	16
~800	1.5	7.8	32	75	18	35	6	16	6	16
	1.75	9.0	32	75	18	35	6	16	6	16
800	2.0	13.4	40	80	25	50	10	25	10	16
	2.5	17.6	63	150	33	67	16	35	16	25
	1.0	6.0	32	75	12	24	6	16	6	16
1000	1.5	10.0	40	80	22	44	10	25	10	16
	1.75	11.7	40	80	22	44	10	25	10	16
	2.0	13.4	40	80	25	50	10	25	10	16
	2.5	17.6	63	150	33	67	16	35	16	25
1150	1.0	7.0	32	75	15	29	6	16	6	16
	1.5	10.6	40	80	19	38	10	25	10	16
	1.75	12.3	40	80	23	47	10	25	10	16
	2.0	14.1	40	80	25	50	10	25	10	16
1350	2.5	17.6	63	150	33	67	16	35	16	25
	1.0	8.8	32	75	19	39	6	16	6	16
	1.5	13.3	50	100	32	63	10	25	10	16
	1.75	15.4	63	150	32	63	16	35	16	25
1600	2.0	17.6	63	150	43	86	16	35	16	25
	2.5	22.1	80	150	43	86	25	50	16	35
	1.0	10.5	40	80	22	44	10	25	10	16
	1.5	15.8	63	150	33	66	16	35	16	25
1800	1.75	18.3	63	150	33	66	16	35	16	25
	2.0	20.9	80	150	46	93	25	50	16	35
	2.5	26.1	80	150	46	93	25	50	16	35
	1.0	14.0	40	80	27	53	10	25	10	16
~2000	1.5	28.0	80	150	50	100	25	50	16	35
	1.75	28.0	80	150	50	100	25	50	16	35

- ▲ Notes 1. The above table is for lengths of electric wire to 50 meters from the machine room to the building transformer.
2. If the cable lengths above 50meters, the following formula should be applied:

$$\text{Power feeder size (mm}^2\text{)} = \frac{\text{Power feeder length(m)}}{50} \times \text{Size in the above (mm}^2\text{)}$$

3. The above power feeder thickness are based on copper wires use and metallic tubing.
4. It is recommended a larger diameter earth wire be used.
5. Please consult us if you need electric power requirements for 220V or 440V Class.
6. For installing several elevators, apply the following formula
Transformer Capacity[kVA] = Number of elevator × Diversity factor

Number of Elevator	1	2	3	4	5
Deversity Factor	1.00	0.91	0.85	0.8	0.76

*By others: To be built by the building owner

WORK TO BE DONE BY OTHERS

CONSTRUCTION WORK

HOISTWAY

1. Forming holes on the wall surrounding the entrance on each floor. (entrance, hall button, hall lantern, etc.), and finishing the walls and floors after installation of the elevator. (including mortar filling)
2. Installation of steel frame to fix the left / right jambs on the entrance.
3. Installation of ladder for pit inspection where there the pit depth not exceeding 2.5 m.
4. Installation of Pit access door where the pit depth exceeds 2.5 m.
- Access door size: Min. 600 mm (W) × Min. 2000 mm (H)
5. Waterproofing work inside the pit and finishing work after installation of the buffer.
6. Installation of hoistway partitions or separating beams. (If necessary)
7. Removing various tie pins and molds.

8. Others. (items indicated on the layout plan)
9. Construction of concrete structures (thickness of 150 mm or above) or steel structures to fix the rail brackets.
10. Destruction and finishing of concrete structures that are not constructed as indicated on the layout plan.
11. Installation of lifting beam or hook that is designed to lift the machine to the top of hoistway.

MACHINE ROOM (MR)

1. Forming holes for machines and ropes on the floor, finishing on cinder concrete, and installation of those indicated on the layout plan.
2. Installation of lifting beam or hook on the top of machine room.
3. Installation of reinforcement beam on the machine room floor. (If necessary)

ELECTRIC WORK

HOISTWAY

1. The natural or artificial lighting of the landings in the vicinity of landing doors shall be at least 50 lux at floor level.
2. Lighting with an intensity of at least 50 lux at 1.0 m above the pit floor everywhere a person can stand and 1.0 m above the car roof within its vertical projection.
3. Lighting with an intensity of at least 20 lux in the whole hoistway.
4. Piping and wiring work from monitoring panel to hoistway when monitoring panel is installed. (Wire specifications: UL2919 × 2 EA per one bank (Max. 20 units))
5. Piping and wiring work when CCTV is installed.
6. Others. (items indicated on the layout plan)
7. Wiring work on power system within the hoistway for supplying power and lighting. (Refer to the layout plan for electrical power requirements.)
8. Installation of distribution box for elevator (including N.F.B) on electrical room. (Install near the hoistway. Refer to the layout plan for electrical power requirements.)
9. Construction for power supply to maintain the voltage regulation of distribution source within ±5% to and lighting within ±2%.
10. Piping and wiring work on lighting outlet for pit inspection.
11. Supplying power needed during installation and commissioning free of charge.
12. Piping and wiring work on emergency communication device between elevator control panel and central control room. (Wire specifications: UTP × 4P per each elevator)

- * Communication device that connects the inside and outside of the elevator should be installed redundantly on the area where the managing personnel is stationed (security office, electric room, and central control room). In case of the facility where the managing personnel is stationed in only one place, only one communication device may be installed.

MACHINE ROOM (MR)

1. Piping and wiring work outside the hoistway for the installation of emergency call equipment (intercom) in a place other than the machine room.
2. Construction of lighting and lighting outlets for inspection in machine room.
3. Supplying power needed during installation and commissioning free of charge.
4. Installation of lighting for power system and car, and construction of machine room incoming panel and its wiring for emergency power.
5. Lighting with an intensity of at least 200 lux at floor level everywhere a person needs to work and 50 lux at floor level to move between working areas.

MACHINE ROOM LESS (MRL)

1. Power supply (Including piping and wiring work) to the control panel and per-manently installed lighting with an intensity of at least 200 Lux from the bottom of the control panel.

MATTERS TO NOTE

1. Exit for machine room should be made of fire-proof material and should be installed in a structure that does not lead to other places.
 2. Do not install ducts or pipes for other purposes (electricity, water, gas, hydrant) on the hoistway and walls inside the machine room.
 3. Lower part of pit should not be used as residence, pathway, or for other purposes.
 4. Power and voltage regulation should be within +5% to -5%.
 5. Temperature in machine room should be 40°C and humidity should be 90% or below. Be sure to install the entilation window, ventilator, or other air-conditioning facilities to prevent generation of dust or poisonous gas inside the machine room.
- * When you wish to build the hoistway in steel frame, please contact us. (Steel frame construction for hoistway is excluded from our supply scope.)
 - * Construction errors: Inner hoistway size that is indicated on the blueprint of this catalog is the minimum size that is designed to fit the size of the elevator interior. So, the construction error limit for hoistway width and overall height is ±20 mm.
 - * Calculation equation for heat generation in machine room (based on one elevator)
Q: (kcal/H) = W × V × F × N V: Rated speed (m/min.)
W: Loading capacity (kg) F: Coefficient based on control type (1/4: VVVF)
N: Number of elevators

GLOBAL SALES & SERVICE NETWORK

HEAD OFFICE & FACTORY

128, Chungjusandan 1-ro, Chungju-si, Chungcheongbuk-do, 27329, Korea

SEOUL OFFICE (GLOBAL SALES DIV.)

5F, East Bldg., Hyundai Group Bldg., 194, Youlgok-ro, Jongno-gu, Seoul, 03127, Korea

AFRICA

EGYPT

T 2-02-24029153,
2-012-23952311
E sales@hauslift.com

ETHIOPIA

T 251-911-503-000
E ieethiopia1@gmail.com

KENYA

T 254-722-667984
E charles.skymax@africaonline.co.ke
pslyall@skymaxenterprise.com

MOROCCO

T 212-522-490-485
E sales@hyundai-ascenseurs.com

NIGERIA

T 234-7034444400
E info@orionelevators.com

TUNISIA

T 212-71-962-967
E ideal.commerciale@gmail.com

ASIA

BANGLADESH

T 88-017-13209212
E zahid@edgeworksbd.com

CAMBODIA

T 855-23-888-399
E project@ggear.com.kh

CHINA

[Head Office (Factory)]
T 86-21-6485-8600
E 2017407@hdl.co.kr

INDIA

T 91-99-7000-0611
E rdmello@kinetic-hyundai.com

INDONESIA

[Service]
T 62-21-3511-355
E marketing@helin.co.id
[New Equipment]
T 62-21-631-8444
E sugiono_nusolim@yahoo.com

MALAYSIA

T 603-7932-1326
E ku.lee@hdl.co.kr
sales@hem.com.my

MONGOLIA

T 976-8908-3031
E munkhtuya@hyundai-elevator.mn

MYANMAR

T 951-2305336~37
E info@integral-ltd.com

PAKISTAN

T 92-21-3432-0601~5
E iitcpk@gmail.com

PHILIPPINES

T 632-8716-0905
E sales@hyundailevator.com.ph

SRI LANKA

T 94-11-2623208
E wasanthaa@abansgroup.com

THAILAND

T 66(0)-2240-3127~8
E ratee@loxley.co.th

VIETNAM

T 84-945-977-417
E ku.lee@hyundailevator.com

EUROPE & CIS

AZERBAIJAN

T 994-50-207-2217
E info@s-enna.az

DENMARK

T 45-3311-3230
E office@s-elevator.com

GREECE

T 210-481-8756
E info@valsalift.gr

KAZAKHSTAN

T 7-701-599-9906
E dmitriy@hdl.kz

KYRGYZSTAN

T 996-707-646-666
E hyundaielavatorstkg@gmail.com

POLAND

T 48-61-820-85-51
E maciej.dziurkiewicz@omilifts.com

ROMANIA

T 40-231-537-138
E office@smartelevators.eu

RUSSIA

[Moscow]
T 7-495-640-30-44
E msk@dvc.ru
[Vladi]
T 7-423-220-51-16
E hyundai@dvc.ru

TURKEY

T 90-216-510-1244
E orkun.tanman@hdl.com.tr

UKRAINE

T 380-44-4969580
E lift@eurolift.com.ua

UZBEKISTAN

T 998-90-910-1368
E innesa@boinnccorp.com

MIDDLE EAST

BAHRAIN

T 973-1770-2468
E elevators@nassgroup.com

IRAQ

T 964-79-1336499
E info@alarjoon.com

ISRAEL

T 972-3-9630000
E lgorv@ledico.com

JORDAN

T 962-79-5526-713
E maadbseiso55@gmail.com

KUWAIT

T 965-2227-0722
E info@dealgtc.com

OMAN

T 968-9936-9663
E techno.hyundai@gmail.com

QATAR

T 974-4436-6689,
974-4427-9565
E info@ietg-hyundailevator.com

SAUDI ARABIA

T 966-12-263-1907
E shoukath@escco.com.sa

UAE

T 971-4-294-4475
E dubai@bhnoe-hyundai.com

NORTH / SOUTH AMERICA

ARGENTINA

T 5411-3220-2878,
5411-4488-1948
E oqueta@skylift.com.ar

BRAZIL

T 55-11-5070-4141
E wellington.sierra@hdl.com.br

CHILE

T 56-9-225540849
E lcid@cyce.cl

COLOMBIA

T 57-4-444-9297
E sgiraldo@solucionesverticales.com.co

COSTA RICA

T 506-2291-0455
E mvelevatec@grupomisol.com

DOMINICAN REPUBLIC

T 809-566-7474
E cesar@elevea.com.do

ECUADOR

T 593-2254-2831
E hyundai@a-i.com.ec

EL SALVADOR

T 503-2260-6233
E jc.elevatec@grupomisol.com

GUATEMALA

T 502-2388-0000
E cd.elevatec@grupomisol.com

HONDURAS

T 504-2564-6150,
504-2231-3302
E jc.elevatec@grupomisol.com

MEXICO

T 52-55-5663-2019
E yurich@insertechmx.com

NICARAGUA

T 505-2223-5217
E bb.elevatec@grupomisol.com

PANAMA

T 507-381-7422,
507-381-7427
E el.elevatec@grupomisol.com

PERU

T 506-7013-4407
E cc.elevatec@grupomisol.com

PARAGUAY

T 595-2120-1915
E egrau@inelec.com.py

USA & CANADA

T 812-705-4057
E Sales@ALT-AVT.com

VENEZUELA

T 58-212-232-8263
E ojsimon@gmail.com



CE marked goods
conform to EU standards.



Korea Certification (KC)
for elevator safety



ISO 9001 certification
(first in the industry
in Korea)



ISO 14001 certification
(first in the industry
in Korea)



ISO 45001
certification

HYUNDAI ELEVATOR CO., LTD.

This publication is for general informational purposes only and the company reserves the right to alter product design and specifications at any time.

Notes

1. Product images have been modified to help viewers' understanding. Design and colors depicted may differ from the actual products.
2. Specifications may differ from those provided in printed materials due to the selection of options or quality improvements.
3. Copyright © HYUNDAI ELEVATOR CO., LTD. All rights reserved.
4.  Please recycle this brochure to protect the environment.

Website



 YouTube

